

MUBEA  
**DISC  
SPRINGS**  
MANUAL





## IMPRINT

### Editor

Mubea Tellerfedern GmbH, Im Kirdorf 34, 57567 Daaden

### Non-liability

This brochure is non-binding informativ material of the company Mubea Tellerfedern GmbH and not a binding product description or a guaranteed feature. This informative material has carefully been compild. Nevertheless, due to the variety of used information, numerous charts and the large part of graphics und piactures, we cannot rule out errors. Therefore, Mubea Tellerfedern GmbH explicitly points out that all information in this brochure is non-binding, that the use of the information given in the brochure happens at one's own risk and that on the part of Mubea Tellerfedern GmbH no liability is assumed.

# LOCATIONS



Mubea Disc Spring locations

- Mubea Group
- Mubea Disc Springs



## HEADQUARTER

**Postal address**  
Mubea Tellerfedern GmbH  
Postfach 120  
57564 Daaden

**Visitor address**  
Mubea Tellerfedern GmbH  
Im Kirdorf 34  
57567 Daaden  
Germany

Phone.: 0049 (0) 2743 806 0  
Mail: [tellerfedern@mubea.com](mailto:tellerfedern@mubea.com)  
[www.mubea.com](http://www.mubea.com)

# TABLE OF CONTENTS

<b>1</b>	<b>INTRODUCTION</b>	
1.1	Mubea Tellerfedern GmbH.....	7
1.2	Product Description of Disc Springs .....	8
<b>2</b>	<b>STATE OF THE ART</b>	
2.1	Generation II Disc Springs .....	11
<b>3</b>	<b>DESIGN AND THEORY</b>	
3.1	Disc Spring Theory .....	12
3.2	Properties and Construction .....	13
3.3	Classification according to DIN EN 16983 (former DIN 2093) .....	14
3.4	Evaluation of Individual Disc Springs .....	14-15
3.5	Disc Springs without Contact Surfaces with Force Application per DIN .....	16
3.6	Load Stresses .....	16-17
3.7	Disc Springs without Contact Surfaces with Force Application through Shortened Lever Arms .....	18
3.8	Disc Springs with Contact Surfaces .....	18
3.9	Special Cases .....	19
3.10	Disc Spring Combinations .....	20-23
3.11	Calculating Allowable Stress Level .....	24-27
3.12	Relaxation and Creep .....	28
3.13	Friction .....	29-31
3.14	General tolerances .....	32
3.15	Materials .....	34
3.16	Materials and Corrosion Protection .....	36
3.16.1	Standard materials .....	36
3.16.2	Corrosion Resistant Materials .....	36
3.16.3	Heat Resistant Materials .....	37
3.16.4	Antimagnetic and Corrosion Resistant Materials .....	38
3.16.5	Thermally stable materials .....	38
3.17	Corrosion Protection .....	40-42
3.17.1	Phosphate Layers.....	42
3.17.2	Galvanic Protective Layers .....	43
3.17.3	Mechanical Galvanizing .....	43
3.17.4	Delta-Tone-/Delta-Seal-Coating .....	43
3.17.5	Geomet 321/500 .....	44
3.17.6	Chemical Nickel Plating .....	44
<b>4</b>	<b>APPLICATION</b>	
4.1	Disc Spring Product Overview .....	45
4.2	Pre-Assembled Spring Stacks .....	46
4.3	Valves .....	46
4.4	Energy Storage for Safety Systems .....	46
4.5	Overload Clutches .....	47
4.6	Slip Clutches .....	47
4.7	Piston Return Springs .....	48

4.8	Spring-Actuated Brakes (Fail Safe Brakes)	48
4.9	Tool Clamping Components	48
4.10	Backlash Compensation	48
4.11	Cableway Grip	48
<b>5</b>	<b>MANUFACTURING / PROCESSES</b>	
5.1	Series Production Process Steps	49
5.1.1	Stamping / Fine Blanking	49
5.1.2	Plasma Cutting	49
5.1.3	De-Burring	50
5.1.4	Forming	50
5.1.5	Turning	50
5.1.6	Hardening and Tempering	50
5.1.7	Shot Peening	51
5.1.8	Deep Rolling	51
5.1.9	Pre-Setting	51
5.1.10	Phosphatizing	52
5.1.11	Stack Design	52
5.2	Sample Shop	52
<b>6</b>	<b>QUALITY CONTROL / VALIDATION</b>	
6.1	Series Accompanying Tests	53
6.2	Fatigue Testing	54
6.3	Other Testings	54
6.4	Material Tests and Investigations	54
<b>7</b>	<b>TRENDS</b>	55
<b>8</b>	<b>LITERATURE</b>	
8.1	Literature Sources	56
8.2	Laws, Standards, Guidelines	56
<b>I</b>	<b>GLOSSARY</b>	
I.I	Latin Symbols	57
I.II	Greek Symbols	57
<b>II</b>	<b>LIST OF FIGURES AND TABLES</b>	
II.I	List of Figures	58
II.II	List of Tables	59
<b>III</b>	<b>STANDARD DIMENSIONS</b> according to DIN EN 16983 (former DIN 2093) and Mubea standards	60-79
III.I	Mubea disc springs made from corrosion resistant materials	80-83
<b>IV</b>	<b>DOWNLOADS</b> Calculation programm / Force-displacement diagrams for standard parts / General infomaterial	84





# 1 INTRODUCTION

## 1.1 MUBEA TELLERFEDERN GMBH

For more than 55 years, Mubea has specialized in the production of quality disc springs. Mubea produces spring dimensions in series with an outside diameter from 8 mm up to over 600 mm. Over 400 dimensions of disc springs according to DIN EN 16983 (former DIN 2093) or Mubea's own company standard are available from the warehouse. Moreover Mubea also produces disc springs having an outer diameter of up to 800 mm, slotted disc springs on the inside and outside and wave springs.

All Mubea disc springs are products of a complete in-house production, beginning with the design of the disc springs, the production of the primary material in the in-house cold-rolling mill and the

manufacturing and maintenance of the required tools. In addition to the standard material 51CrV4, Mubea offers many different material types in order to be able to satisfy particular product requirements – anti-magnetic, corrosion resistant and heat resistant – to ensure a high degree of flexibility. The main focus of Mubea Tellerfedern GmbH is on consulting customers to be able to implement their requirements in the best possible way. Mubea is working with specialized design programs to calculate the best spring solution for customer-specific applications. FEM calculations, material analyzes, residual stress measurements, Corrosion tests etc., as they are part of the prototype or series phase can occur in our own laboratories.

---

## 1.2 BRIEF DESCRIPTION OF THE DISC SPRING

Disc springs are flat, conical rings that are loaded in the axial direction. They are distinguished by a large spring force with limited spring displacement and an efficient utilization of space.

Because of these properties, the disc spring is suitable as a kit element with which a variety of different curve configurations can be realized.

Compared with coil springs, disc springs provide a higher spring force at small structural spaces. Depending upon the relationship of height vs. disc thickness the degression of the spring force curve can be varied over a wide range. Also, the spring

forces and deflections can be increased according to the demands by arranging the discs parallel or in series in a stack differently. Due to these specific advantages Mubea discs are deployed in many different areas of applications, in safety valves for oil rigs in great sea depth, many applications in industry and plant engineering as well as special functions in satellites.

The designs of disc springs are mostly optimized to customer's demands and therefore the so called special dimensions deviate from the standard dimensions of DIN EN 16983 (former DIN 2093).



# 2 MUBEA STANDARD

Mubea sets the standard for a high level of quality and efficiency through production innovations and a high vertical range of manufacture, which, as already indicated, begins with the production of the disc spring material. The disc springs are manufactured according to the specifications of DIN EN 16983 (former DIN 2093) and additionally according to the Mubea factory standard, which overall exceeds the requirements of the DIN standard. An example is the production step of shot peening, which significantly increases the service life of the disc springs. This manufacturing step is also an important distinguishing feature compared to competitors. (Fig. 2.1)

For standard applications, the materials of DIN EN 16983 (former DIN 2093) are adequate. However, because of the high in-house quality requirements, Mubea uses the material 51CrV4 as the standard material.

Zinc phosphatizing and oiling are used as standard corrosion protection. Other surface coatings can be implemented at the customer's request. Special requirements for corrosion resistance, heat resistance and anti-magnetism can be met using special materials.

Disc springs are typically designed for the particular necessities of each case. In addition to the disc springs of DIN EN 16983 (former DIN 2093) the additional dimensions of the Mubea factory standard as well as other so-called special dimensions can be drawn upon as references. Moreover, there is the possibility of designing disc springs having dimensions apart from the standard. The customer requirements are the benchmark for the design of these springs. Mubea provides a calculation program for the design of these individual disc springs.

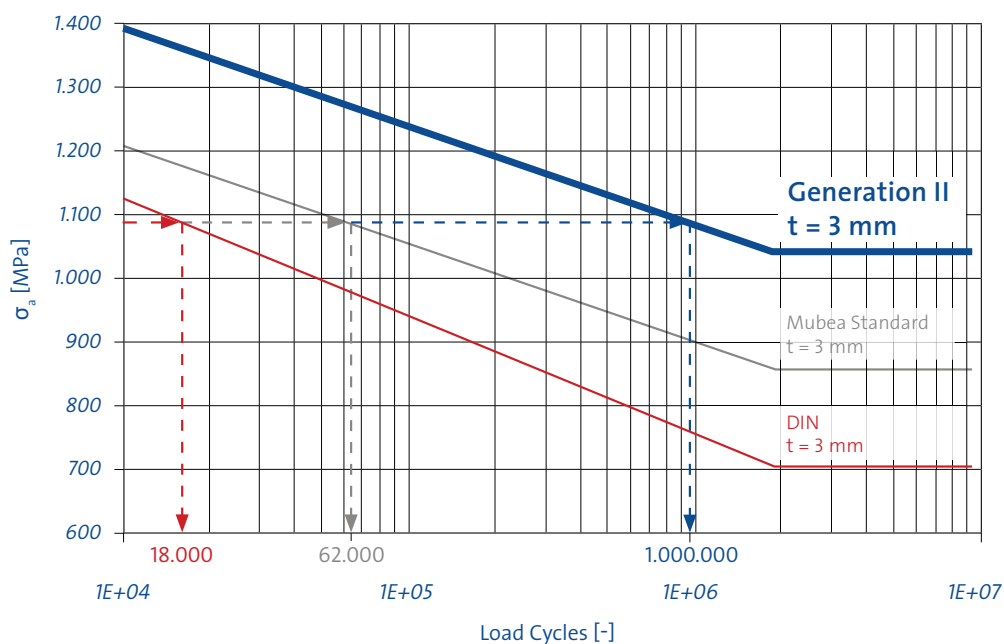

Fig. 2.1: Service life comparison

## 2.1 GENERATION II DISC SPRINGS

The disc springs of the second generation represent a further development. (Fig. 2.3)

Via an additional work step, deep rolling, the residual compressive stresses at critical points are significantly increased.

The deep rolling can be done partially or on the spring bottom, depending on the requirement.

### *Advantages of using Gen II disc spring stacks*



*... the outer diameter can be reduced up to 25 %  
... the installation space can be reduced up to 33 %  
... the lifetime can be increased up to 10 times*

Fig. 2.3: Second Generation disc springs

# 3 DESIGN AND THEORY

## 3.1 DISC SPRING THEORY

Disc springs are flat conical rings that are exposed to axial loads. Normally the ring thickness is constant and the applied load is evenly distributed over the upper inside and lower outside edges. Disc springs are generally manufactured from spring steel and can be subjected to static loads, infrequently alternating loads, and dynamic loads. With a correct design, disc springs can meet the most stringent fatigue life and set loss requirements. (Fig. 3.1)

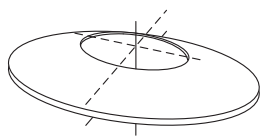

Fig. 3.1: Single disc spring

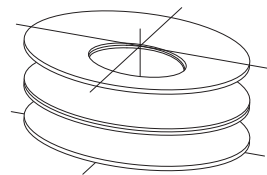
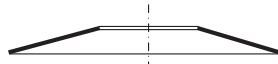

Fig. 3.3: Disc spring stack

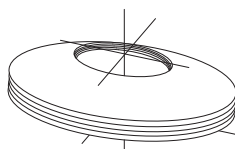
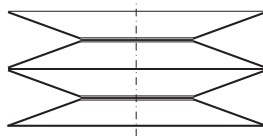

Fig. 3.4: Disc spring pack



Disc springs are distinguished from other spring types by the following characteristics:

- High load capacity with a small spring deflection
- Efficient space utilization when compared with other spring types
- High fatigue life and low set loss and creep when properly sized
- Cost-effective as a result of standardized sizes
- Different combination of springs can be designed to achieve the desired load characteristics
- Appropriate for high and low temperature applications as well as corrosive environments through correct material and coating selection

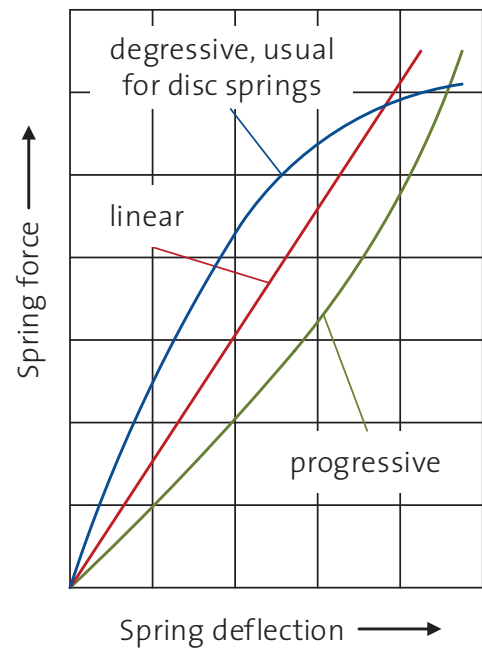

Fig. 3.2: Typical load curve

### 3.2 PROPERTIES AND CONSTRUCTION

The characteristic load curve is a representation of the force-deflection behavior of the spring. Depending upon the dimensional ratios, the characteristic load curve of a disc spring is more or less degressive up to the flat position. In special cases, disc springs can be designed so that deflection beyond the flat position is possible.

(Fig. 3.2)

Typically, disc springs are used as modular components. A group of individual disc springs stacked facing the same way is called a parallel spring stack. A group of individual disc springs or parallel spring stacks that are stacked facing alternate ways is called a series spring stack. In a parallel spring stack, the deflection of the stack is equal to that of the individual spring. The load at a given deflection is proportional to the number of individual springs in the stack. In a series spring stack, the deflection of the stack is the sum of the deflections of the individual springs.

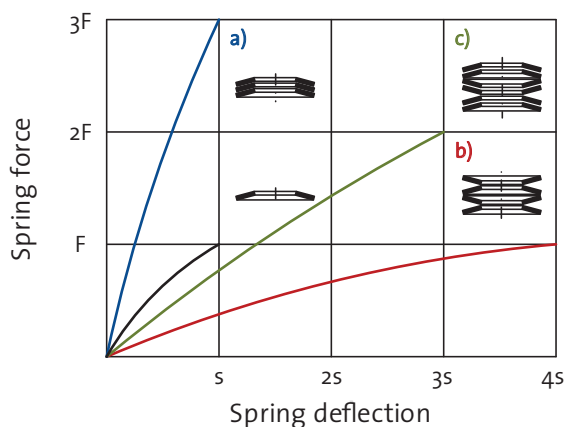

Combination of disc springs to yield a progressive load curve:  
**a)** Stack of 3 springs in parallel: force multiplied by 3  
**b)** Stack of 4 springs in series: deflection multiplied by 4  
**c)** Series stack consisting of 3 parallel stacks, each parallel stack contains 2 individual springs: deflection multiplied by 3, force multiplied by 2

The load of the stack is equal to the load on the individual spring.

When calculating the spring deflection and load capacity of a stack composed of individual springs or spring packs these facts must be taken into consideration. (Fig. 3.3/Fig. 3.4)

It is possible to generate progressive characteristic curves by combining parallel spring stacks containing different numbers of disc springs or single disc springs of varying thickness to form a stack. In these cases the packs or single discs with the lower load capacity do not contribute to the deflection of the stack after reaching the flat position or their upper stroke limits, with the result that the total spring rate of the stack rises.

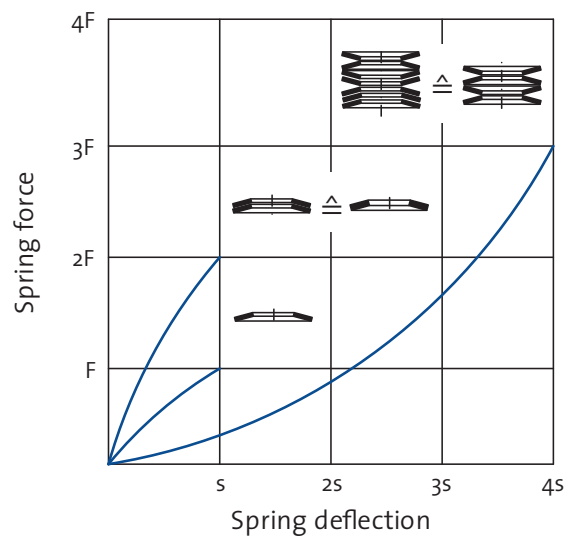

Fig. 3.5: Various disc spring combination (left), progressive load curve (right)

### 3.3 CLASSIFICATION ACCORDING TO DIN EN 16983 (FORMER DIN 2093)

Disc spring design, sizing, and manufacturing have been standardized to DIN EN 16984 (former DIN 2092) (Disc Springs, Calculation) and DIN EN 16983 (former DIN 2093) (Disc Springs, Calculation, Dimensions, Quality Requirements). Disc springs in accordance with DIN EN 16983 (former DIN 2093) are classified into 3 groups:

- Group 1: Disc thickness,  $t$ , less than 1.25 mm
- Group 2: Disc thickness,  $t$ , from 1.25 mm to 6 mm
- Group 3: Disc thickness,  $t$ , over 6 mm up to 14 mm

Group 1 and 2 springs are manufactured without contact surfaces, group 3 springs are manufactured with contact surfaces. (Fig. 3.6)

The requirements of springs manufactured to DIN EN 16983 (former DIN 2093) are summarized in the following table: (Tab. 3.1)

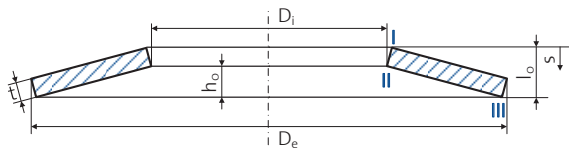

### 3.4 EVALUATION OF INDIVIDUAL DISC SPRINGS

Although more accurate analytical equations exist for the evaluation of disc spring behavior, the simplified equations of DIN EN 16984 (former DIN 2092) are sufficiently accurate. The equations in DIN EN 16984 (former DIN 2092) are essentially derived from calculations developed by ALMEN and LÁSZLÓ.

According to these equations, the deformation behavior of the disc spring is treated as a one-dimensional inversion of a circular ring of rectangular cross-section about a center of inversion  $S_o$ . The resulting inverted stress condition is overlaid by a bending stress condition caused by the change in the cone angle resulting from the deflection.

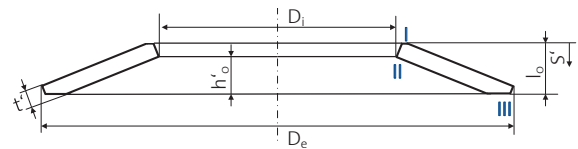

Fig. 3.6: Group 1 + 2 without contact surfaces (left), group 3 with contact surfaces (right)

Group	Production Method	Surface Finish**)	
		Upper and lower surface [ $\mu\text{m}$ ]	Inner and outer edges [ $\mu\text{m}$ ]
1	stamped, cold formed, edges rounded	$R_a < 3,2$	$R_a < 12,5$
2 <sup>1)</sup>	stamped, cold formed, $D_e$ and $D_i$ turned, edges rounded	$R_a < 6,3$	$R_a < 6,3$
	fine-blanked, cold formed, edges rounded	$R_a < 6,3$	$R_a < 3,2$
3	cold or hot formed, turned on all sides, edges rounded	$R_a < 12,5$	$R_a < 12,5$

\*) Unless otherwise specified, the manufacturing process is left to the discretion of the manufacturer (see section 5 in DIN EN 16983 (former DIN 2093)).

\*\*\*) The specified values do not apply to shot-peened disc springs.

Tab. 3.1: Production method and permissible surface finish



The cross-section of the disc spring remains rectangular, so that force is always applied at the edges I and III. The behavior of the material is regarded as linear-elastic without limit. Residual stresses are not taken into account. The calculated stresses are nominal stresses. Mubea has computer-aided calculation programs available for the design of disc springs.

Relative calculated characteristic load curves:  
(Fig. 3.7)

- Deflection: refers to the spring deflection up to flat position  $s = s_c = h_0$
- Spring force: refers to the spring force in the flat position  $F_c = F(h_0)$

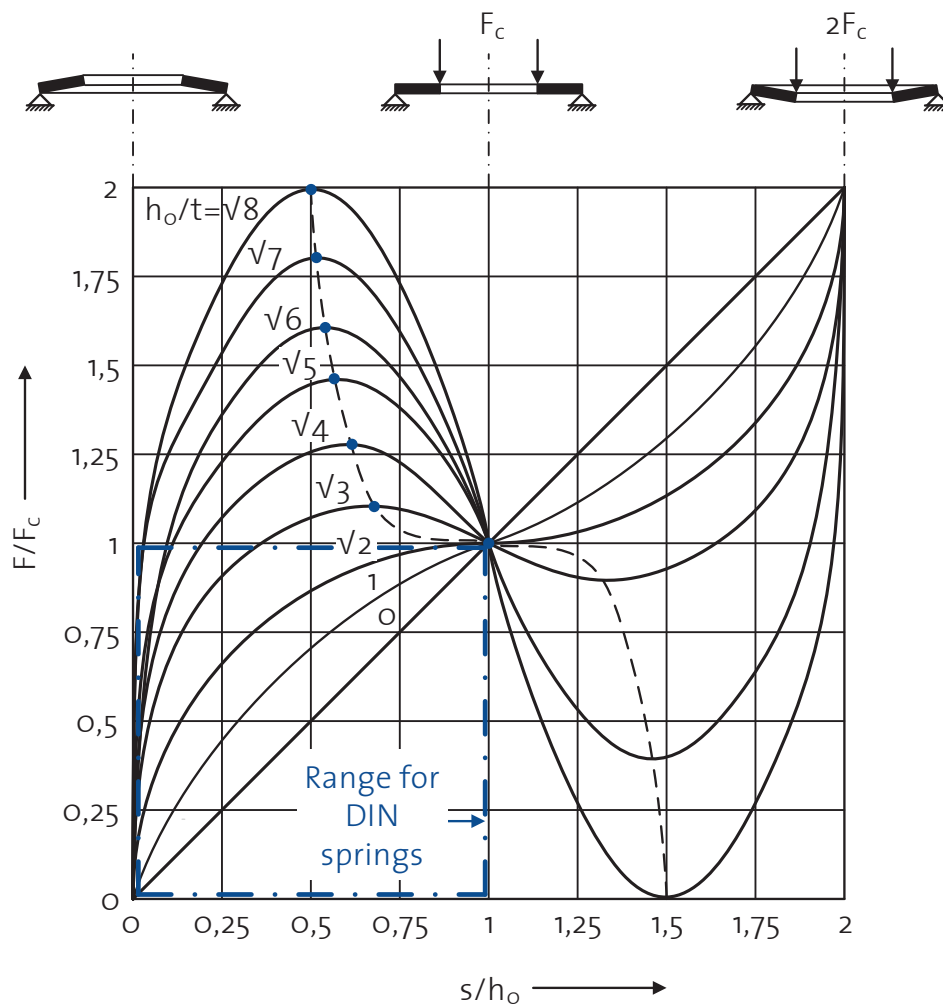

Fig. 3.7: Possible load characteristics

### 3.5 DISC SPRINGS WITHOUT CONTACT SURFACES WITH FORCE APPLICATION AS PER DIN

The characteristic load curve for a disc spring is defined by the  $h_0/t$  ratio. Assuming unrestricted spring deformation and adherence to permissible load limits, the characteristic load curves shown in Fig. 3.7 are obtained. The characteristic curves shown in Fig. 3.8 are specifically for Series A, B and C springs standardised according to DIN 2093 (former DIN 2093).

- Deflection: refers to the spring deflection down to flat position  $s = s_c = h_0$
- Spring force: refers to the spring force in the flat position  $F_c = F(h_0)$

### 3.6 LOAD STRESSES

The fatigue life of the disc spring is dependent upon the stresses that run tangentially, while the stresses running radially are negligibly small. Typically, compressive stresses act on the upper side of the disc and tensile stresses on the lower side. The calculated stresses do not correspond to the actual stresses in the spring. This is due to residual stresses caused by shot-peening and pre-setting.

The actual stresses are a combination of the residual stresses and the load stresses. The dynamic strength of the spring is dependent upon the tensile stresses on the underside of the disc. Due to the residual stresses introduced in our production process, the calculated stress levels are higher than the actual stress levels.

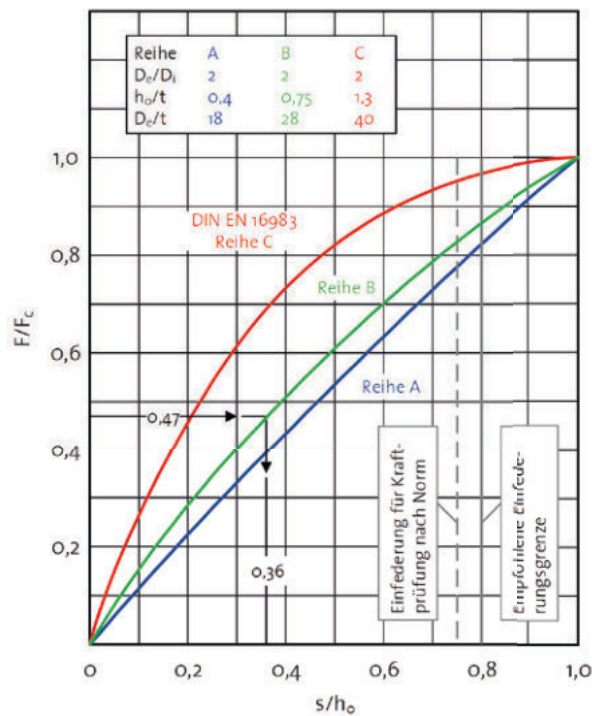

Fig. 3.8: Theoretical load curve

Depending on the  $h_0/t$  ratio, the maximum tensile stress will occur at cross-section point II (inner diameter bottom) or III (outer diameter bottom). On the upper side of the spring, the maximum compressive stress occurs on the inside edge of the spring at cross-section point I.

This stress determines the set loss of the spring. Setting is caused by plastic deformation of the disc spring due to high deflections that exceed the elastic limit of the material. This results in a reduction in the free height of the spring.

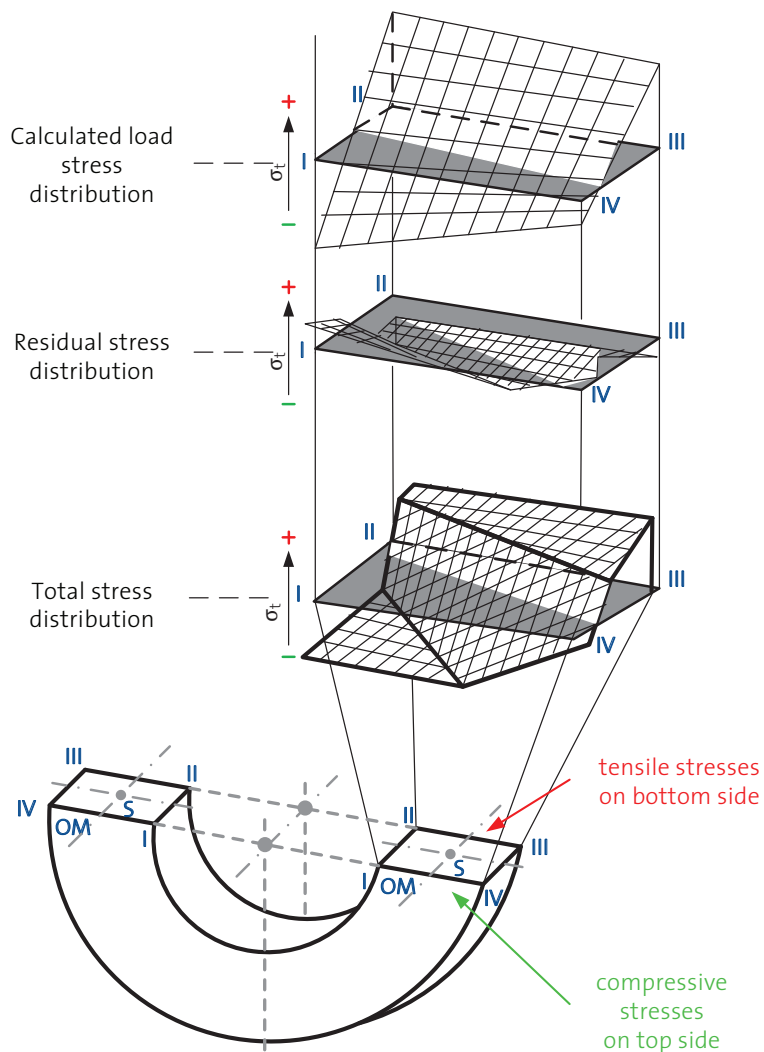

Fig. 3.9: Superimposing stresses and residual stresses result in total stresses



### 3.9 SPECIAL CASES

#### Conversion when using special materials

The characteristic equations applicable to a sharp-edged rectangular cross section yield forces which are 8 % to 9 % too high for spring steel where  $E = 206,000 \text{ N/mm}^2$  and  $\mu = 0.3$ . This is compensated by shortening the lever arm due to the radii at points I and III. Therefore, the calculated and measured loads for steel springs correlate closely. This is no longer true if special materials, especially ones with higher POISSON ratio  $\mu$ , are used.

#### Extremely thin disc springs

In the case of disc springs where  $D_e/t \gg 40$ , the characteristic equation yields a force which is too high. In this case, the cross section of the spring is no longer rectangular and deflection over the spring cross section must be taken into consideration (especially if a finite element analysis is made).

#### Extremely smaller diameter ratio

In the case of disc springs with  $D_e/D_i < 1.8$ , the shortening of the lever arm due to the corner radii must be taken into consideration when calculating the characteristic load curve. Otherwise the calculated load will be too low.

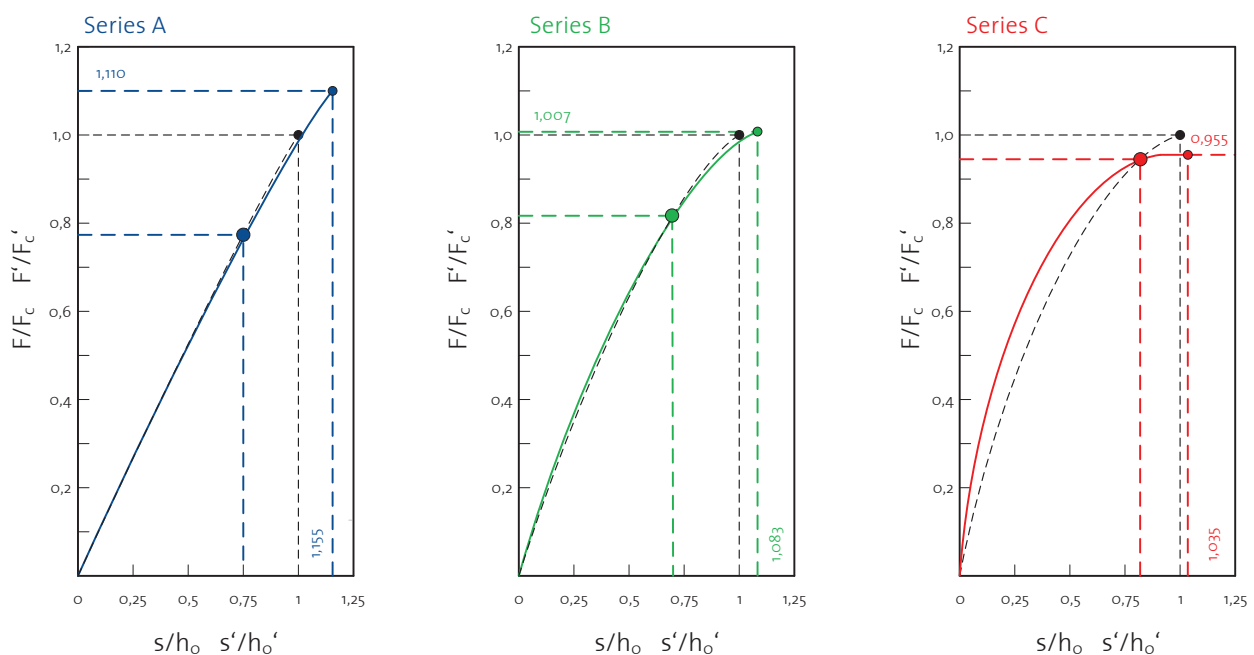

Fig. 3.12: Comparison of the calculated characteristic curves of disc springs with and without contact surfaces

### 3.10 DISC SPRING COMBINATIONS

As already mentioned at the beginning of this section, disc springs can be combined in many different ways to form parallel or series stacks or a combination thereof. The following information is only for disc springs without contact surfaces. It can also be applied to disc springs with contact surfaces. However, it must be noted that the reduction of the disc thickness from  $t$  to  $t'$  results in a shortening of the parallel spring stack or series spring stack containing groups of parallel spring packs.

### SPRING STACK DESIGN

#### Stack of disc springs in parallel (Fig. 3.13)

For spring stacks consisting of  $n$  identical disc springs arranged in parallel, the force calculated for a single spring is multiplied by a factor  $n$  for a constant spring deflection (the deflection is enlarged for clarity). The length  $L_0$  of the unloaded spring stack is calculated as:  $L_0 = l_0 + (n-1) \cdot t$ . If friction is disregarded, the following equations are obtained:

- Deflection:  $s_{\text{tot}} = s$
- Spring force:  $F_{\text{tot}} = n \cdot F$

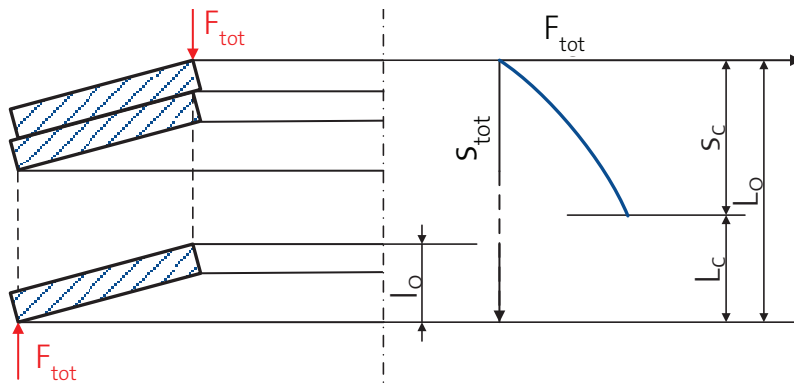

Fig. 3.13: Spring stack out of  $n$  individual springs

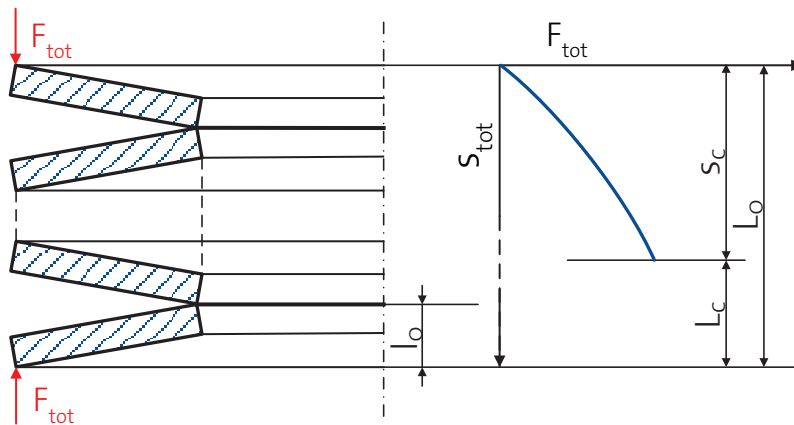

Fig. 3.14: Series spring stack consisting of  $i$  individual disc springs

### Stack of disc springs in series (Fig. 3.14)

For spring stacks consisting of  $i$  individual disc springs arranged in series, the deflection is multiplied by a factor of  $i$  for a constant load.

The length of the unloaded series spring stack of single springs is calculated as:  $L_o = i \cdot l_o$

If friction is disregarded, the following equations are obtained:

- Deflection:  $s_{tot} = i \cdot s$
- Spring force:  $F_{tot} = F$

### Progressive characteristic load curves (Fig. 3.15)

Progressive characteristic load curves can be obtained with the use of parallel stacks having different numbers of disc springs combined to yield compound series stacks (high friction) or series stacks comprised of individual disc springs of varying thickness and overall height (low friction).

The progression is achieved because the weaker stack – or weaker spring – is canceled out and thus no longer contributes to the compression of the stack after reaching either the flat position or the deflection limiter.

Figure 3.15 for example: Two spring stacks with stroke limiters are used to avoid overloading.

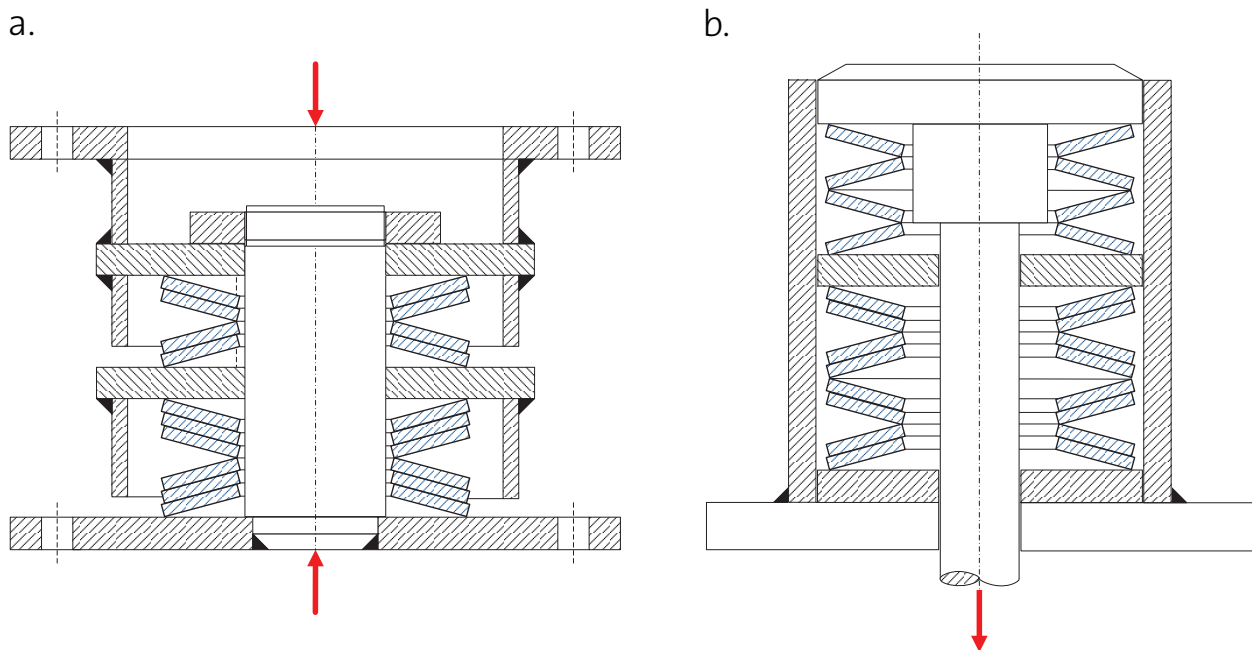

Fig. 3.15: Spring stacks with progressive load curve and stroke limiters a. bell, b. stop

## SPRING STACK DESIGN GUIDELINES

The following guidelines should be considered in the design of disc spring stacks:

- Individual springs stacked in series are used if the deflection of the individual spring is not sufficient
- Single springs stacked in parallel are used if high loads have to be obtained in a limited mounting space
- A large spring diameter enables a low overall height to be achieved.
- Normally no more than 2–4 springs should be stacked in parallel since the discrepancies between the calculated and measured characteristic load curves increase with an increasing number of discs due to friction. Since the coefficient of friction is depending on many influencing factors such as the geometry, the coefficient of friction, the roughness and the lubrication and can also be severely affected by the ambient and operating conditions, it is only possible to predict the friction to a limited extent.

### Spring stack guides (Fig. 3.16)

Both series and parallel spring stacks should be guided. However, it should be noted that self-centering spring columns have a slightly larger height due to the additional elements. This is done with a guide element such as :

- A guide rod (internal guidance a.)
- A guide sleeve (external guidance b.) or by
- Self-centering devices (balls c.) or by hardened wire segments

For spring columns with special requirements for low hysteresis, the use of self-centering disc spring columns is recommended. The intermediate elements bring about very defined contact properties and, in the case of the parallel arrangement, prevent the conical surfaces from touching, which results in a significant reduction in the hysteresis.

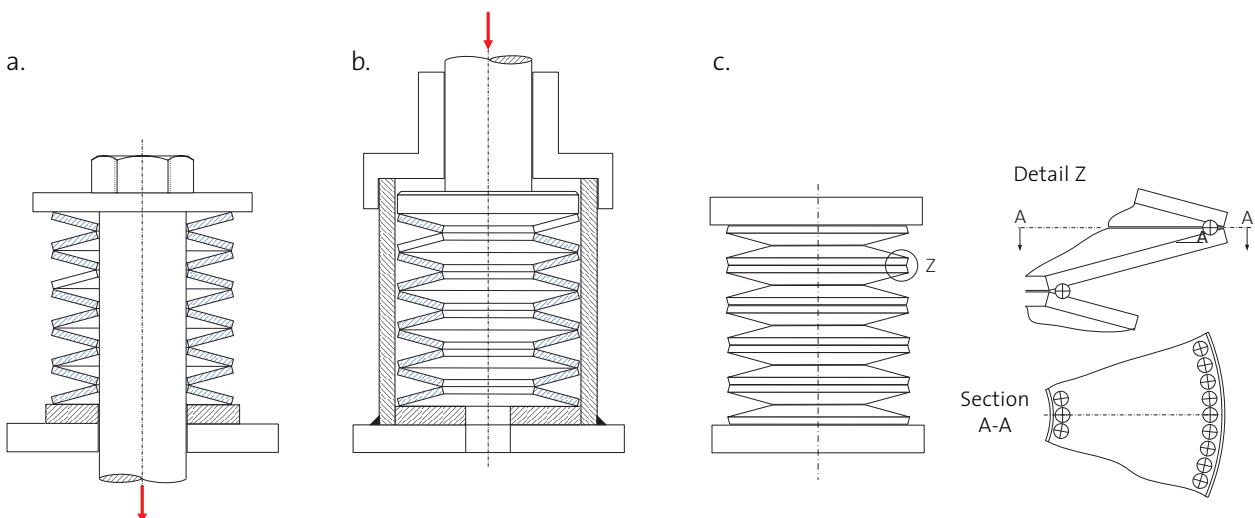

Fig. 3.16: Different types of spring stack guides



Both internal and external guides should be polished over their entire length and hardened to at least 55 HRC. In the case of purely static or rarely alternating loads, an unhardened guide element can be used.

In spring stacks, the load can be applied via either the inner or the outer diameter. If the load is applied via the inner diameter the contact pressure will be higher due to less contact surface.

Both internal and external guides require some clearance,  $T$ , between the spring stack and the guide element. This allows adequate room for the displacement of the lubricant while ensuring proper guidance. The following table shows the total clearance,  $T$ , for both disc spring inner diameter  $D_i$  (in the case of internal guides) and disc spring outer diameter  $D_e$  (in the case of external guides).

$D_i$ or $D_e$ [mm]	Total clearance $T$ [mm]
Up to 16	0,2
over 16 up to 20	0,3
over 20 up to 26	0,4
over 26 up to 31,5	0,5
over 31,5 up to 50	0,6
over 50 up to 80	0,8
over 80 up to 140	1,0
over 140 up to 250	1,6
over 250	2,0

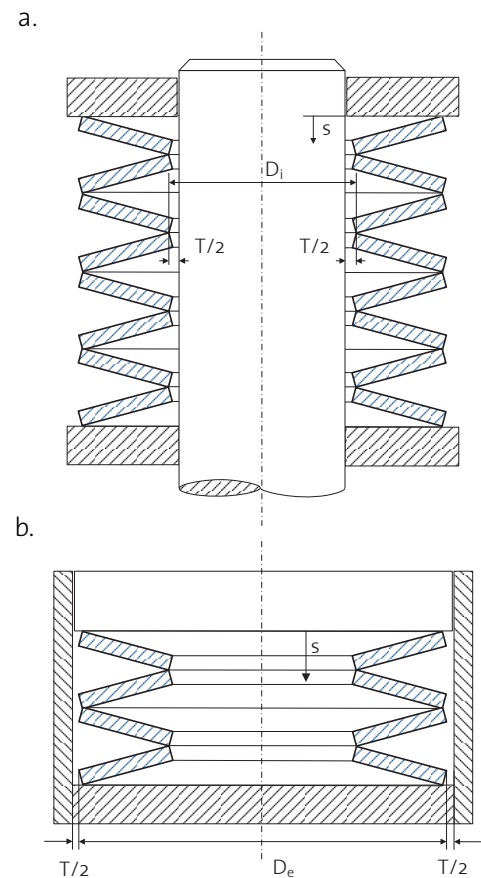

Fig. 3.17: Spring stack guides (left); total clearances (right)

### 3.11 CALCULATING ALLOWABLE STRESS LEVEL

The allowable stresses depend upon the loading type of the spring.

3 types of loading are considered:

1. Static or rarely alternating loads with fewer than  $10^4$  load cycles over the required life of the spring
2. Alternating loads with  $10^4 < N < 2 \cdot 10^6$  load cycles over the required life of the spring
3. Alternating loads with  $N > 2 \cdot 10^6$  load cycles over the required life of the spring

#### Relating to 1.

For applications with a static or rarely alternating load, the highest calculated stress at the upper inner edge of the single spring (cross-sectional point I) is the most critical. The stress at cross-sectional point I has the highest magnitude and thus determines the set loss of the spring. For springs made of high-grade steels as specified by DIN EN 10089 and DIN EN 10132-4, the compressive stress calculated for point I should not exceed the values specified in the following table in the flat position  $s_c = h_o$  (Tab. 3.2)

$D_e/D_i$	$\sigma_{lc}$ [N/mm <sup>2</sup> ]
1.5	- 2,600
2.0	- 3,400
2.5	- 3,600

Tab. 3.2: Maximum permissible stresses in the flat condition

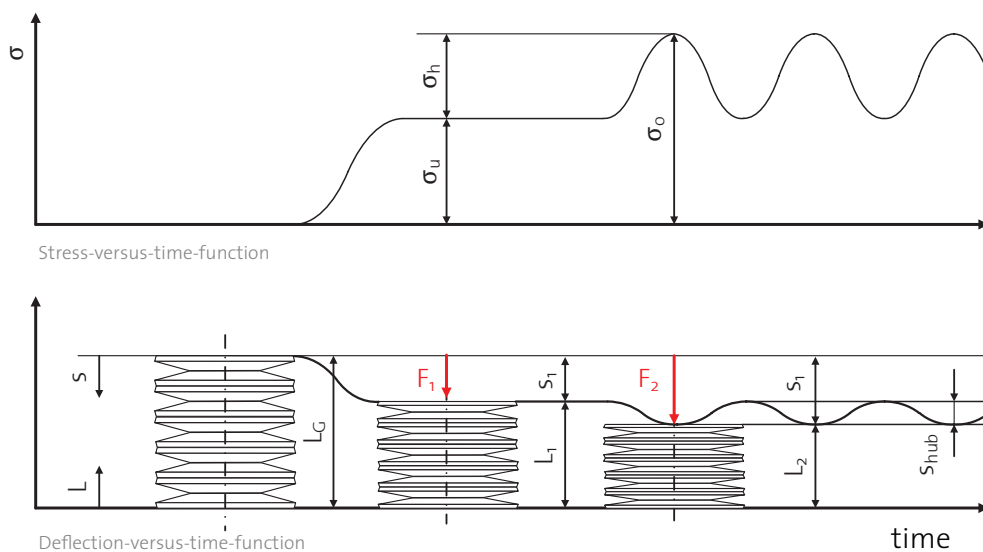

Fig. 3.18: Representation of motion as a function of time during dynamic loading

---

In the case of higher compressive stresses, the spring may undergo a high degree of setting. If the maximum permissible calculated compressive stresses are exceeded in the case of special sizes, such springs can also undergo a high degree of setting.

#### Relating to 2. and 3.

For applications with dynamic loading, the maximum tensile stresses on the lower side of the disc spring are critical. Fatigue fracture always begins on the lower side of the spring. Fracture will begin at cross-section II or III, depending upon which position the higher cyclical stress level has.

#### Minimum preload

---

For springs subjected to dynamic loading, the disc spring must be installed with sufficient preload to prevent fracture at the upper inside edge (cross-sectional point I). Radial surface cracks may occur at the upper inside edge due to residual tensile stresses caused by the pre-setting process.

Experience shows that the minimum compressive stress should be about  $\sigma_{\lambda} = -600$  N/mm<sup>2</sup>. This corresponds to a preload deflection of  $s_u \approx 0,15 \cdot h_0 \dots 0,20 \cdot h_0$ . While springs with lower stresses in the flat condition can have a lower preload deflection, a larger preload deflection is needed for springs with very high stresses in the flat condition.

## Fatigue strength values

The following fatigue strength graph for  $N = 2 \times 10^6$  load cycles is based upon many years of testing. It shows the permissible calculated stress on the underside of the disc spring that is decisive for fatigue failure. The fatigue strength graph has been calculated for disc springs of varying size and thickness and with varying numbers of load cycles.

The graph applies to disc springs of group 2 and 3 made of 51CrV4 and disc springs of group 1 made of C67 S. The maximum fatigue life can be achieved with a statistical probability of 99 % under the following conditions:

1. Spring stacks must be limited to a maximum of 10 individual disc springs arranged in series
2. The spring or spring stack must be subjected to a sinusoidal deflection-versus-time-function with a constant deflection at a constant frequency below the permissible thermal limit
3. Spring stacks must be assembled on guide elements (rod or sleeve). The load must be applied via hardened and polished plates at the stack ends
4. Proper lubrication
5. Operation at room temperature and normal atmosphere (i.e. no excessive humidity, no corrosive chemicals, etc.)

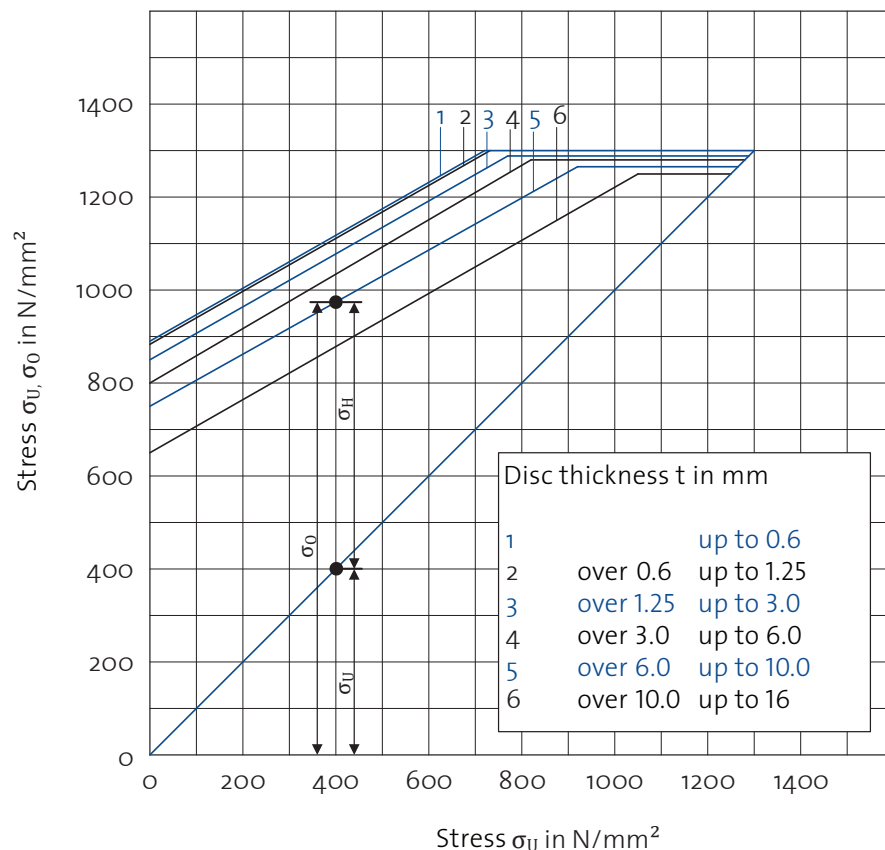

Fig. 3.19: Fatigue strength diagram for  $N = 2 \times 10^6$  load cycles

Deviations from these test conditions may reduce the number of load cycles that can be achieved. This applies especially to sudden loads that can occur during operation in the case of faulty lubrication, or when corrosion and surface imperfections are present.

As the number of disc springs in a stack increases, the number of load cycles that can be achieved is reduced in comparison to a single disc spring. One reason is the varying deflection of the individual springs within the stack.

This is influenced by:

- Friction between the springs and guide rod
- Friction between the springs in parallel stacks

Mubea disc springs can accept higher dynamic stress levels, or operating cycles, compared to the requirements of the DIN EN 16983 (former DIN 2093) standard. This is shown in the fatigue strength diagrams where the dynamic stresses and the allowable stresses are compared to the corresponding values in DIN EN 16983 (former DIN 2093). (Fig. 3.20)

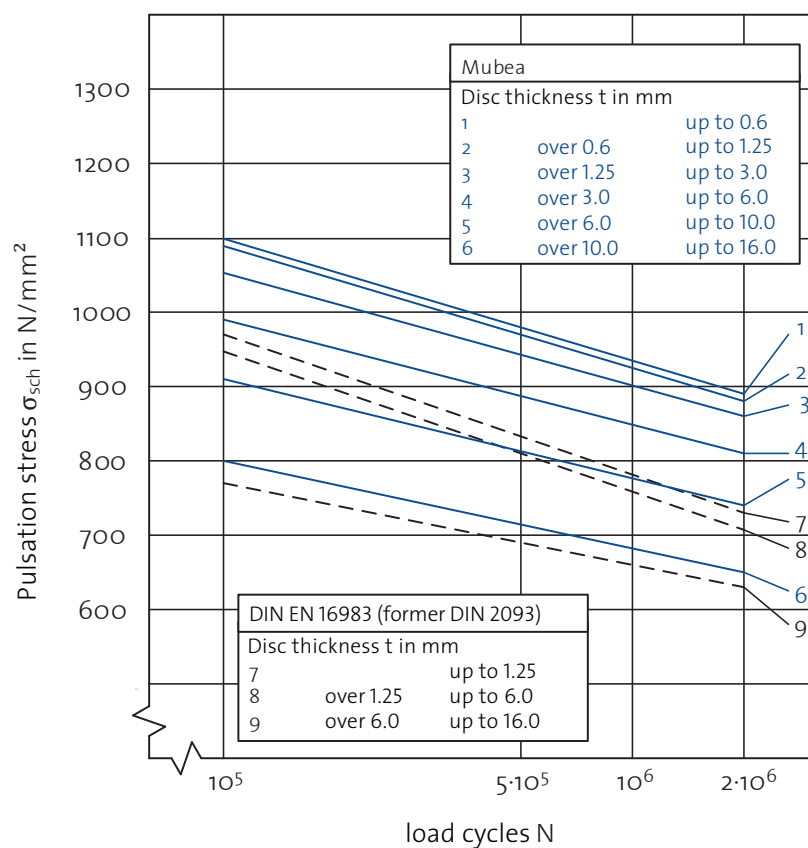

Fig. 3.20: Wöhler diagram showing comparison between Mubea and DIN EN 16983 (former DIN 2093)

### 3.12 RELAXATION AND CREEP

With time, all springs undergo a loss of elasticity. Depending on the type of load imposed on the spring, this loss of elasticity results in either relaxation or creep.

Relaxation is the decrease of force,  $\Delta F$ , seen with time if a spring is compressed to a constant length. Creep is the decrease in spring height,  $\Delta l$ , seen with time if the spring is subjected to a constant load. The amount of relaxation or creep is effected by the following factors:

- The load stresses, especially  $\sigma_1$
- The residual stresses resulting from the pre-setting process
- The operation temperature
- The material strength, especially at high temperatures (hot strength)
- The duration of load application

Permissible relaxation for disc springs made of chrome vanadium-alloy steels per DIN EN 10089 and DIN EN 10132-4.

Hot-preset springs have approximately the same residual stresses at the surface as cold preset springs. However, the zone of plasticity extends more deeply into the material, and therefore the slope of the residual stress is less steep. This results in lower set loss when compared with cold-preset springs.

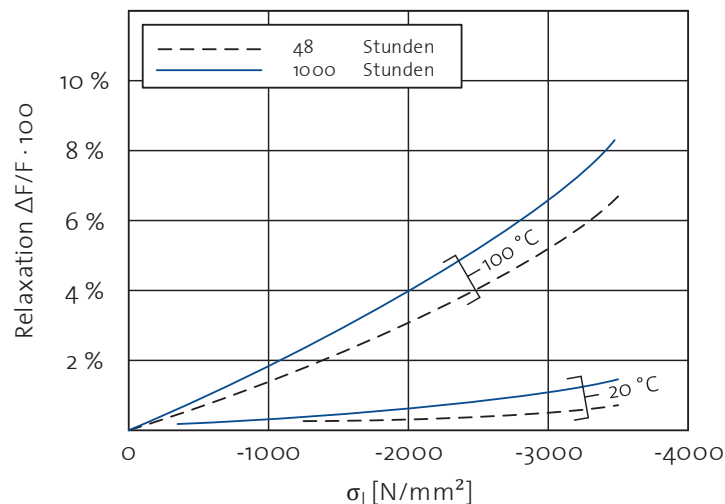

Fig. 3.21: Permissible relaxation of disc springs

### 3.13 FRICTION

Depending upon the spring arrangement, frictional forces arise during the compression and extension of springs between individual springs, between the springs and the guide element, and at the edges of the spring where load is applied. This results in a variation between the calculated characteristic load curve and the actual loading and unloading characteristic load curves for a given application.

#### Friction for an individual disc spring

As shown in Fig. 3.22, during compression frictional forces  $\mu_R \cdot F(\mu_R)$  create a moment that counteracts the moment of the applied load and thus increases the required compression force  $F(\mu_R)$ . During extension, frictional forces create a moment acting in the same direction as the load moment and therefore reduce the required retaining force. The actual coefficients of friction depend upon the surface finish of the components

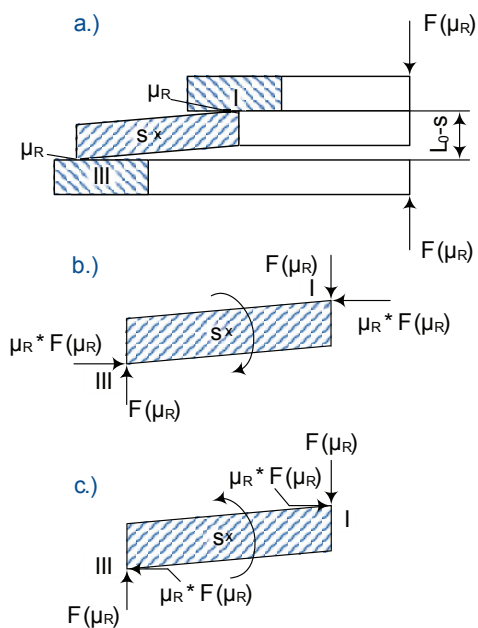

Fig. 3.22: Individual disc spring with edge friction  
a) Overall view b) Compression c) Extension

through which the load is applied, the radii at edges I and III of the disc spring, and the lubricant used.

#### Friction in stacks of disc springs arranged in parallel

When a parallel spring stack consisting of  $n$  discs is compressed, radial frictional forces  $\mu_M \cdot F(n, \mu_M)$  acting in opposing directions occur on the surfaces of contacting disc springs (Fig. 3.23). These frictional forces are in addition to those created at the edges where the load is applied to the spring stack. This results in  $n$  frictional moments which counteract the moment of the applied load and thus increase the required compression force. During the release stroke, frictional forces reduce the required retaining force.

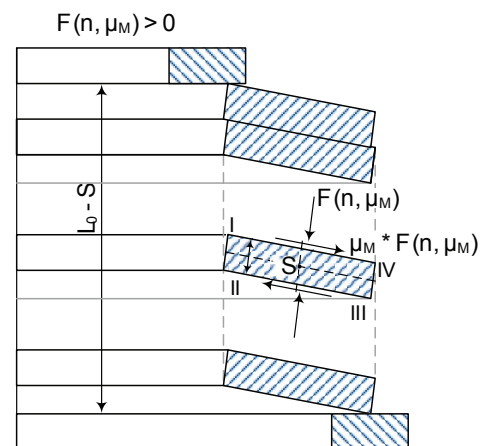

Fig. 3.23: Friction forces on a parallel stack of disc springs

The actual deviation in load is independent of the spring deflection. The use of thicker disc springs (Series A) results in a greater damping effect. Experience shows that the characteristic load curve deviates more from the characteristic load curve as the numbers of springs arranged in parallel increases (Fig. 3.24). This is due to the accumulation of the geometrical variations of the individual disc springs from their ideal shape, particularly out-of-roundness on the surface area of the cone and deviations in the overall height  $l_0$ .

If springs are moved or even rotated within a stack, slightly different characteristic load curves will occur. In general, however, over time a steady state loading and unloading characteristic curve is established. For safety reasons, even a single stack of springs arranged in parallel should be provided with internal or external guidance. If disc springs with a low friction design are used, the resulting frictional forces are usually negligible.

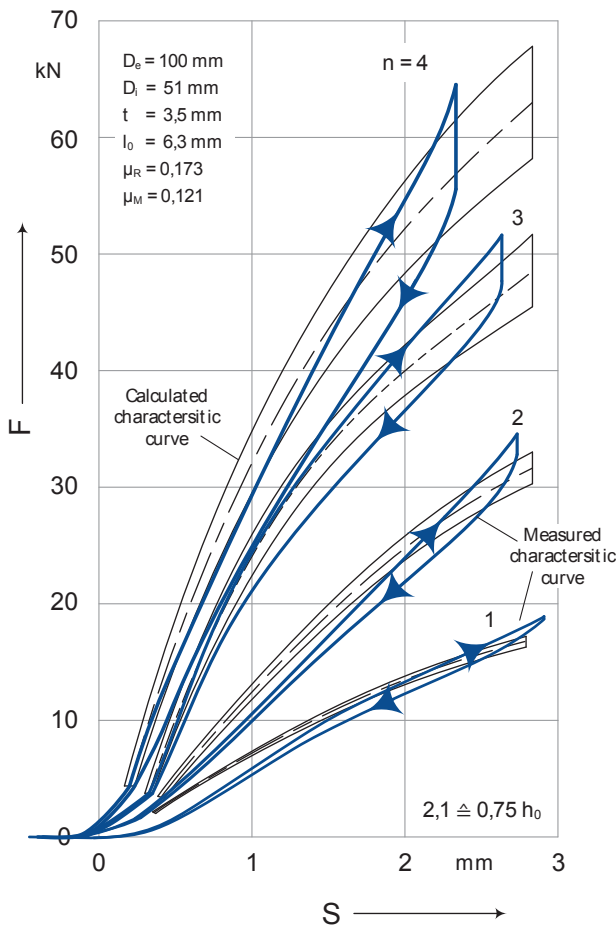

Fig. 3.24: Comparison of measured and calculated characteristics load curves for an individual disc spring and a parallel stack comprised of 2 to 4 disc springs



### Friction in stacks of disc springs in series

In series spring stacks, it is assumed that disc springs of low friction design are used. For example, the springs are designed with a special inner edge contour that minimises the friction between the guide rod and disc spring stack. This results in the uniform deflection of the disc springs in a stack of individual springs arranged in series. The risk of premature spring fracture from over-stressing the springs at the moving end of the stack is thereby reduced.

Fig. 3.25 shows the difference in deflection of the individual disc springs in both low friction and high friction spring stacks. The characteristic load curves measured during loading and unloading for series stacks of disc springs of low friction design differ slightly from one another as well as the calculated characteristic load curve (Fig. 3.26). If parallel stacks of disc springs are used in the series stack, these almost ideal conditions

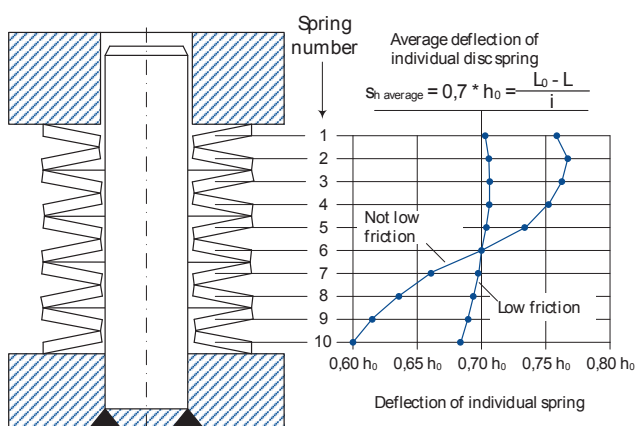

Fig. 3.25: Deflection of individual disc springs in a series stack

no longer apply. Deviations in the ideal geometry of the individual disc springs result in an uneven transmission of load from one spring to the next in parallel stacks. This results in lateral displacement of the springs, which are then pressed with great force against the guide element. If such laterally displaced springs are located at the moving end of the stack, the lateral forces generate a high amount of friction because of the large spring deflection. Therefore, it should be emphasised that the use of parallel stacks of disc springs in a series stack can result in non-uniform deflection of the individual springs and in a higher operating temperature at high frequency. This results in a reduction of the fatigue life of the spring stack.

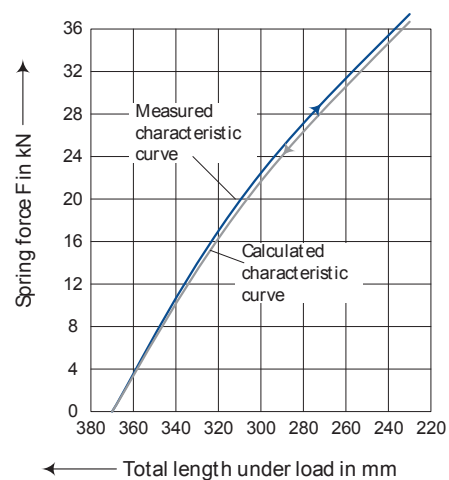

Fig. 3.26: Comparison between the measured and the calculated characteristic load curves for a spring stack consisting of 10 springs arranged in series

### 3.14 GENERAL TOLERANCES

Tolerances for spring geometry, load, and hardness are specified in Table 3.3 and 3.4. These tolerances are valid for Mubea's entire product range. In the case of the springs manufactured per DIN EN 16983 (former DIN 2093), the tolerances for the outside and inside diameter correspond to  $h_{12}$  or  $H_{12}$ . If tighter tolerances are required, Mubea should be consulted.

	Material thickness t or t' [mm]	allowable tolerance in material thickness t [mm]	allowable tolerance in free height $l_0$ [mm]	allowable tolerance in spring force F at $l_0$ -s with $s = 0.75 h_0$ [%]	Hardness [HCR]
Group 1 springs without contact surfaces	0,2 to 0,6	+ 0,02 - 0,06	+ 0,1 - 0,05	+ 25 - 7,5	42-52
	> 0,6 but < 1,25	+ 0,03 - 0,09			
Group 2 springs without contact surfaces	1,25 to 2,0	+ 0,04 - 0,12	+ 0,15 - 0,08	+ 15 - 7,5	
	> 2,0 to 3,0		+ 0,20 - 0,10		
	> 3,0 to 3,8		+ 0,3 - 0,15	+ 10 - 5	
	> 3,8 to 6,0				
Group 3 springs with contact surfaces	> 6,0 to 15	± 0,10	± 0,30	± 5	
	> 15 to 25	± 0,12	± 0,50*		
	> 25 to 40	± 0,15	± 1,0*		

\* applies only to disc springs with a ratio  $De/t \leq 20$

Tab. 3.3: Allowable tolerances for material thickness, free height, spring force

When the ratio  $D_e/t > 20$ , a larger tolerance for the free height is typically required. In this case, actual tolerances should be reviewed with Mubea.

Outside diameter $D_e$ , Inside diameter $D_i$			
$D_e$ or $D_i$ [mm]	$D_e h_{12}$ [mm]	$D_i H_{12}$ [mm]	Concentricity tolerance for $D_e$ [mm]
3 to 6	0 to -0,12	0 to +0,12	0,15
> 6 to 10	0 to -0,15	0 to +0,15	0,18
> 10 to 18	0 to -0,18	0 to +0,18	0,22
> 18 to 30	0 to -0,21	0 to +0,21	0,26
> 30 to 50	0 to -0,25	0 to +0,25	0,32
> 50 to 80	0 to -0,30	0 to +0,30	0,6
> 80 to 120	0 to -0,35	0 to +0,35	0,7
> 120 to 180	0 to -0,40	0 to +0,40	0,8
> 180 to 250	0 to -0,46	0 to +0,46	0,92
> 250 to 315	0 to -0,52	0 to +0,52	1,04
> 315 to 400	0 to -0,57	0 to +0,57	1,14
> 400 to 500	0 to -0,63	0 to +0,63	1,26
> 500 to 600	0 to -0,68	0 to +0,68	1,36

Tab. 3.4: Allowable tolerances for material thickness, free height, spring force and spring hardness

### 3.15 MATERIALS

Applications profile	Material designation	DIN Material Number	Modules of elasticity at 20°C [N/mm <sup>2</sup> ]
Standard Material	C67 S	1.1231	206.000
	51 CrV 4	1.8159	206.000
High material thickness	51 CrMoV 4	1.7701	206.000
Corrosion resistant	X 10 CrNi 18-8	1.4310	190.000
	X 7 CrNiAl 17-7	1.4568	200.000
	X 5 CrNiMo 17-12-2	1.4401	190.000
Thermally stable	X 39 CrMo 17-1	1.4122	209.000
	X 22 CrMoV 12-1	1.4923	209.000
Antimagnetic and corrosion resistant	Cu Be 2	2.1247	135.000
High temperature	Inconel 718	2.4668	200.000
	Inconel X 750	2.4669	214.000
High strength titanium alloy	TiAl 6 V 4	3.7165	114.000

<sup>1)</sup> field of experience, greater material thicknesses upon request <sup>2)</sup> with hot pre-setting up to 200°C

\* Standard dimensions and materials ex stock, special dimensions and materials upon request

Tab.3.5: Materials

Max. material thickness <sup>1)</sup> [mm]	operation temperature range [°C]	Typical application
1.25	-10 up to 100	Plant construction, machine tools, automotive
28	-40 up to 150 <sup>2)</sup>	
40	-20 up to 150	Plant construction
3.5	-150 up to 200	Food processing industry, chemical industry
16	-200 up to 200	
3	-200 up to 200	
8	-60 up to 300	Boilers, power plant construction, industrial furnaces and ovens, chemical industry
14	-60 up to 350	
6	-250 up to 150	Electrical equipment, low-temperature applications, super-conductors, satellites
16	-200 up to 500	Boilers, industrial furnaces and ovens, chemical industry
8	-200 up to 500	
10	-70 up to 350	Oil industry

---

## 3.15 MATERIALS AND CORROSION PREVENTION

### 3.15.1 STANDARD MATERIALS

#### C67S (1.1231)

C67S is the most economical spring steel for low stress applications. Per DIN EN 16983 (former DIN 2093) , this material is only used for group 1 springs (material thickness < 1.25 mm). In special cases it may also be used for disc springs with a thickness of up to 4 mm. However, since 51 CrV 4 is the standard material for most springs, it is often worth using 51 CrV 4 due to better material availability and negligible material cost differences.

#### 51 CrV 4 (1.8159)

At Mubea, 51 CrV 4 is the most commonly used material for disc springs. Because of its high alloy content, it offers the best spring properties in the temperature range of -15 °C to +150 °C. If a reduction in durability is acceptable, this material can be used at temperatures down to -40 °C. With hot-pre-setting the material may also be used at temperatures up to +200 °C. Its relaxation behavior is due to the additional alloying elements better than the behavior of unalloyed steels.

#### 51 CrMoV 4 (1.7701)

51 CrMoV 4 has properties similar to 51 CrV 4. Due to the addition of molybdenum, parts with a material thickness of up to 40 mm can easily be through-hardened. 51 CrMoV 4 also has a higher ductility than 51 CrV 4, making it more suitable for applications with operating temperatures in the range 0 °C to -40 °C.

### 3.15.2 CORROSION-RESISTANT MATERIALS

Because of their high nickel alloy content, corrosion-resistant materials have an austenitic crystal lattice in their initial state. In other words, they cannot be martempered or austempered as is done with standard materials. In contrast, corrosion-resistant spring steels obtain their strength by mixed crystal formation, cold working during rolling (see DIN 17 224) and by precipitation hardening (X 7 CrNiAl 17 7). A strength sufficient for springs is achieved only after a certain degree of cold working. Consequently, narrow limits are set for the maximum material thickness of the material. Springs made from corrosion-resistant materials can also be used at extremely low temperatures. However, the strength obtained by cold rolling is lost at temperatures above +200 °C.

#### X 10 CrNi 18-8 (1.4310)

X 10 CrNi 18-8 to DIN 17 224 is a chrome-nickel alloy commonly used for corrosion-resistant disc springs. This material obtains its strength by cold rolling. Therefore, the maximum material thickness that can be used for disc springs is limited to 3.5 mm. Cold rolling also magnetises the parts to a certain degree. The necessary strength can be obtained by both cold forming as well as by precipitation hardening.

**X 7 CrNiAl 17-7 (1.4568)**

X 7 CrNiAl 17-7 per DIN 17224 is a precipitation-hardened, corrosion-resistant spring steel. It obtains its strength both by cold rolling and by precipitation hardening. X 7 CrNiAl 17-7 steel is highly magnetic in the soft state. Cold working makes the material even more magnetic.

**X 5 Cr Ni Mo 1810 (1.4401)**

X 5 Cr Ni Mo 1810 per DIN 1.4401 is highly corrosion-resistant and typically can not be magnetised. The strength such as X 10CrNi 18-8 is achieved by cold hardening so that the material thickness is limited to approximately 1.6 mm.

**3.15.3 THERMALLY STABLE MATERIALS**

Most thermally stable materials are martempered steels. Because of their high alloy content, they exhibit a lower level of creep in the higher temperature ranges when compared with standard materials. The upper operating temperatures stated in Table 5.1 are based on long term exposure to high temperatures. The springs may also be exposed to temperatures around 100 °C higher than those listed for short periods (up to about 1 hour) without affecting their properties. When designing disc springs, it must be kept in mind that the modulus of elasticity decreases as the temperature rises and increases as the temperature falls.

Therefore, a disc spring will have a lower force at temperatures above room temperature and a higher force at temperatures below room temperature. For springs manufactured from thermally stable materials premature failure due to brittle-fracture is possible.

**X 39 CrMo 17-1 (1.4122)**

X 39 CrMo 17-1 has a high thermal stability due to the addition of molybdenum. This material is also corrosion-resistant when used in some applications. However, its corrosion-resistance is limited at the material strengths required for disc springs. In seawater or similar environment this material is not corrosion-resistant.

**X 22 CrMoV 12-1 (1.4923)**

This material is a heat-treatable molybdenum and vanadium steel containing thermally stable chrome for applications with operating temperatures of - 60° C to 350° C. X 22 CrMoV 12-1 may fail prematurely due to brittle-fracture.

---

#### 3.15.4 ANTIMAGNETIC AND CORROSION-RESISTANT MATERIALS

These materials obtain their strength by precipitation hardening. They are both antimagnetic and corrosion-resistant.

##### Cu Be 2 (2.1247)

Cu Be 2 is precipitation-hardened copperberyllium alloy that can be used at extremely low temperatures. Due to its low modulus of elasticity when compared with other materials, springs made of Cu Be 2 generate much lower spring forces. Cu Be 2 also has good electrical conductivity.

#### 3.15.5 HIGH TEMPERATURE MATERIALS

A number of precipitation-hardenable materials from the group of nickel-base alloys are used for disc springs operating at elevated temperatures. They are highly ductile and have very high fatigue strength. When designing springs made of high temperature materials, the lower tensile strength and unfavourable elastic limit - tensile strength ratio must be taken into account. Otherwise, a high degree of setting loss is possible.

It is not possible to specify an upper operating temperature limit. The overall height of the spring decreases under load due to creep. The actual level of creep is a function of temperature, time and stress. For example, a spring can be used at elevated temperatures if either a lower load is applied or the duration at the elevated temperature is short.

Therefore, the values in Table 3.3 can serve only as guide for the maximum temperatures at which the disc springs will exhibit the same behavior as at room temperature.

It must be kept in mind that the modulus of elasticity is somewhat lower in the upper temperature limit of the material. Taking this into account, disc springs made of thermally stable materials can be used at temperatures up to approx. 150 °C higher than those stated in Table 3.3.

The lead times for thermally stable materials are typically very long. If material is in stock, the delivery times for production orders are the same as for normal steel springs. It should also be noted that thermally stable materials are typically very expensive.





### 3.17 CORROSION PROTECTION

Comparison of various corrosion prevention processes (recommended values):

Plating process	Coating composition	Coating thickness [µm]
Phosphating	Zinc phosphate + oil	≥ 5
Phosphating	Zinc phosphate + wax	10 - 40
Electro-galvanizing	Zinc	≥ 8
Electro-galvanizing	Zinc	≥ 12
Electro-galvanizing + passivation	Zinc + passivation	≥ 8
Electro-galvanizing + passivation	Zinc + passivation	≥ 12
Mech. zinc plating	Zinc	≥ 12
Mech. zinc plating + passivation	Zinc + passivation	≥ 12
Delta-Tone	Zinc phosphate + zinc powder coating	≥ 8
Delta-Tone / Seal	Zinc phosphate + zinc powder coating + organ. topcoat	≥ 12
Geomet 321 A	anorganic zinc-aluminum-flake-coating	≥ 6
Geomet 321 B	anorganic zinc-aluminum-flake-coating	≥ 8
Geomet 500 A with PTFE	anorganic zinc-aluminum-flake-coating	≥ 5
Geomet 500 B with PTFE	anorganic zinc-aluminum-flake-coating	≥ 8
Chem. nickel plating	nickel	approx. 25

**Furthermore we also offer other, customized coatings on request.**

Tab. 3.4: Overview Corrosion Protection

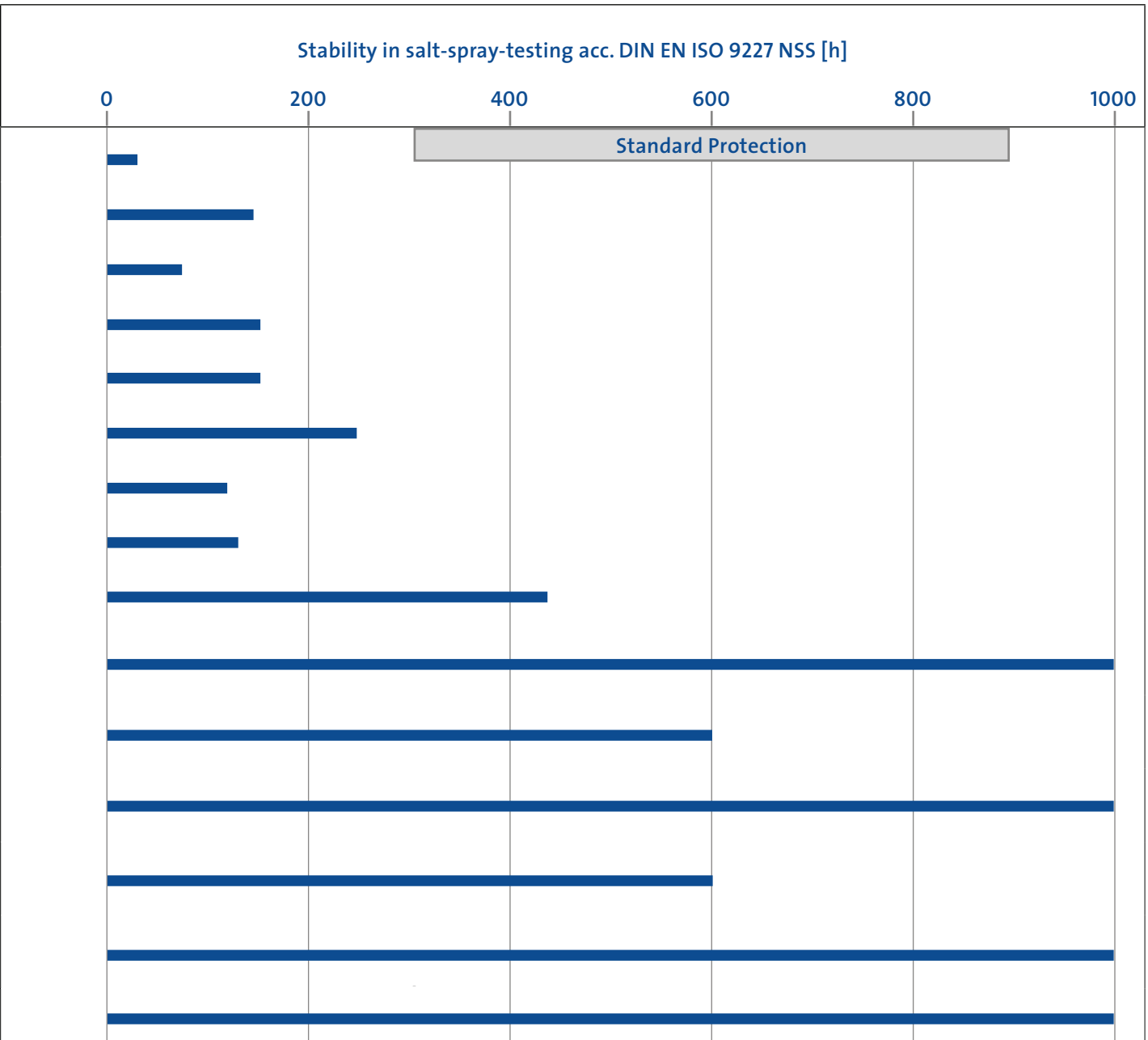

---

### 3.16 CORROSION PROTECTION

Mubea disc springs are capable of withstanding severe loads while operating at very high stress levels. Therefore, suitable measures must be taken to protect the disc spring surfaces from chemical or electrochemical corrosion. There are a variety of coating processes to prevent corrosion. Table 3.4 lists some of the corrosion resistant surface coatings and processes available as well as their relative corrosion resistance when subjected to a salt spray test per the requirements of DIN EN ISO 9227.

The values for the coating thickness listed for galvanizing and nickel-plating are examples of the protection values attainable. It is also possible in some cases to use a greater coating thickness. In the case of mechanical galvanizing and chemical nickel-plating it is possible to obtain a coating thickness up to 50 µm. For disc springs stacked in parallel, there may be problems with the coatings especially on the lateral surfaces of the spring where there is relative motion between the springs. In such cases Mubea should be consulted. In the following, the coatings customary with Mubea are explained in more detail.

If the coating you require is not underneath, please contact us. Many other coatings are possible if the application methods do not involve an increased risk of hydrogen embrittlement and no critical temperatures are required for the coating.

---

#### 3.16.1 PHOSPHATE COATINGS

##### Zinc phosphate + oiling/waxing

Zinc phosphating and oiling is the standard corrosion protection used for disc springs according to DIN 2093 and Mubea's factory standards. During phosphating, fine-crystalline structures of metallic phosphate are deposited on the base metal. A more durable corrosion resistant coating is achieved if an additional protective coating such as oil or wax is applied. Due to production limitations, waxing can only be used on springs with an outside diameter of 100 mm and greater. This type of corrosion prevention is suitable for indoor applications and properly weather-proofed outdoor installations.

##### Manganese phosphate

On request, Mubea can also offer a manganese phosphate coating for disc springs. Manganese phosphate coatings do not offer any corrosion protection. They only serve as a lubricant. A small degree of protection against corrosion can be achieved by oiling prior to transport and storage.

### 3.16.2 GALVANIZING

When metal coatings are precipitated from aqueous solutions, there is a possibility that hydrogen will diffuse into the surface of the spring. This is particularly the case with the high-strength spring steels used for disc springs. A hydrogen-induced, delayed brittle-fracture (hydrogen embrittlement) may occur. The risk of hydrogen embrittlement can be reduced by a suitable thermal treatment process after galvanising (effusion annealing), but not completely eliminated. Where possible, coatings applied by electrolytic galvanizing should be avoided because of the risk of hydrogen embrittlement.

#### Electro-galvanizing

Zinc is chemically more basic than steel. Zinc protects itself by reacting with the atmosphere to form passive protective coatings. If the zinc coating is damaged, it protects steel cathodically. The level of protection against corrosion is roughly proportional to the thickness of the zinc coating. Additional protection can be provided by adding a passivation. Passivation coatings are available in various colours. A subsequent thermal treatment is required to expel the hydrogen. Galvanic coatings are applied mostly for decorative purposes and are used for both indoor and outdoor purposes.

### 3.16.3 MECHANICAL ZINC PLATING

Mechanical zinc plating offers the same level of corrosion protection as electro-galvanizing, but without the risk of hydrogen embrittlement. In the mechanical zinc plating process a zinc powder is applied to the disc spring by the barrelling method. It is recommended that a subsequent chromate coating also be applied. Mechanically zinc-plated springs can be used for same range of applications as for springs that are electro-galvanized.

### 3.16.4 DELTA TONE/DELTA SEAL COATING

Delta Tone is an inorganic coating, consisting of zinc and aluminum compounds. Bright silver coatings with high corrosion-preventive properties are obtained through a baking process. The coating is electrically conductive and thus protects the spring against corrosion cathodically. There is no risk of hydrogen embrittlement.

Delta Seal is an organically based coating. A strongly adhesive, chemical-resistant coating is produced after a suitable application and baking process. Delta Seal can also be applied “with internal lubrication” that serves as a longlasting dry lubrication. Delta Tone and Delta Seal are heavy-metal-free. This high-quality corrosion preventive medium is used mostly to protect springs against corrosion in outdoor applications.

---

### 3.16.5 GEOMET 321/500







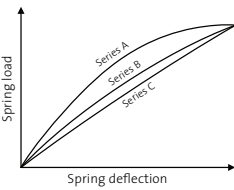

Geomet is a chromium-free, water-based, thin-layer coating of passivated zinc and aluminum lamellas in metallic silver color. Also with this coating, the zinc lamellas ensure cathodic protection of the spring material with slight damage in the coating. Depending on the spring size and weight, the coating is applied to drum or frame material by immersion, centrifugal or spraying. There is no danger of hydrogen embrittlement. If the layer thickness is sufficient, comparable resistances can be achieved as with DeltaTone / Seal. In variant 500, the coating contains the lubricant PTFE. Due to the high mechanical stresses of the coating PTFE has only a limited friction-reducing effect.

### 3.16.6 CHEMICAL (ELECTROLESS) NICKEL PLATING

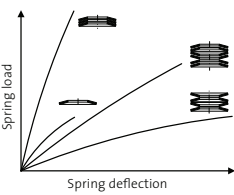
Chemical nickel plating, also known as electroless nickel plating, is a high-quality coating that is wear-resistant and decorative while providing protection against corrosion. Because of the nature of the chemical nickel-plating process, hydrogen embrittlement may occur. The chemical nickel-plating of disc springs is done in dipping units. Nickel-plated disc springs are typically used in applications where they are exposed to high mechanical and chemical stresses.

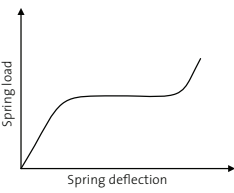
# 4 APPLICATION

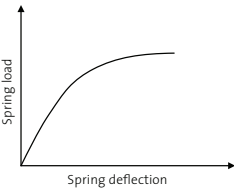
## 4.1 DISC SPRING PRODUCT OVERVIEW

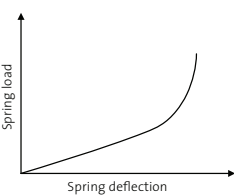
Spring type	Appearance	Spring characteristic	Typical applications
Conventional disc springs			<ul style="list-style-type: none"> <li>■ Boiler suspension systems in power plants</li> <li>■ Safety valves</li> <li>■ Overload protection in electric transformers</li> <li>■ Clutches</li> <li>■ Aerial cable cars</li> <li>■ Machine tool clamping components</li> <li>■ Safety brakes for lifts and elevators</li> <li>■ Brakes for construction and railway vehicles</li> <li>■ Backlash compensation for ball bearings vibration isolation, etc.</li> </ul>
			
Slotted disc springs*			<ul style="list-style-type: none"> <li>■ Automatic transmissions</li> <li>■ Overload clutches</li> <li>■ Clutches, etc</li> </ul>
Special springs*			<ul style="list-style-type: none"> <li>■ Adapted to specific installation requirements               <ul style="list-style-type: none"> <li>– Clutches</li> <li>– Gearboxes, transmissions, etc.</li> </ul> </li> </ul>
Wave springs			<ul style="list-style-type: none"> <li>■ Automatic transmissions</li> <li>■ Backlash compensation</li> </ul>

\* Only drawing parts

Tab. 4.1: Product overview

---

## 4.2 PRE-ASSEMBLED SPRING STACKS

Plant construction, power station construction, machine construction (Fig. 4.1)

Spring stacks are used for boiler suspension systems. The spring assemblies compensate for localized deflections in the bearing surface and thus guarantee an even lowering of the boiler with load fluctuations due to thermal expansion.

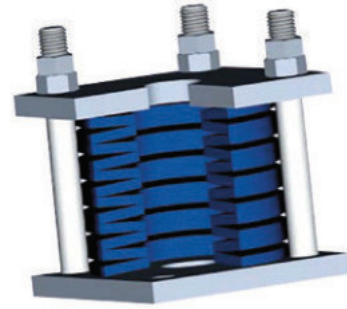

Fig. 4.1: Schematic representation of a disc spring stack in a guide cage

## 4.3 VALVES

Plant construction, machine construction, chemical industry (Fig. 4.2)

In quick-action stop valves, the disc spring stack is hydraulically preloaded when in the open position. If a failure occurs, the hydraulic pressure drops and the disc spring stack is released, closing the valve and thus interrupting the flow. Often ball-centered disc spring stacks are used for this purpose.



Fig. 4.2: Schematic representation of a safety valve

## 4.4 ENERGY STORAGE FOR SAFETY SYSTEMS

Circuit breakers, machine construction (Fig. 4.3)

In hydraulic spring mechanisms, energy storage is often achieved by means of a disc spring stack.



Fig. 4.3: Schematic representation of an energy storage system with springs



#### 4.5 OVERLOAD CLUTCHES

Plant construction, machine construction, motor vehicle construction (Fig. 4.4)

In overload clutches, disc springs provide the load required to maintain sufficient friction to transmit the torque. The load level can be regulated with adjuster nuts. If overload occurs, the transmission of torque is interrupted.

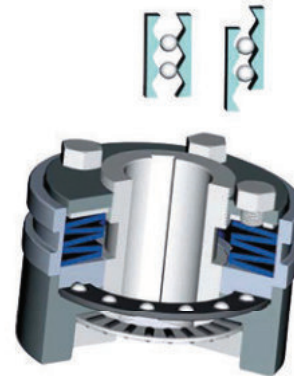

Fig. 4.4: Schematic representation of an overload clutch

#### 4.6 SLIP CLUTCHES

Plant construction, machine construction, motor vehicle construction (Fig. 4.5)

In slip clutches the disc spring provides a defined axial pressure on the friction linings. Wear on the friction linings over the life of the clutch is compensated for by the disc spring, thereby maintaining a constant torque level. Slotted disc springs with a flat load curve are especially well suited to this type of application.

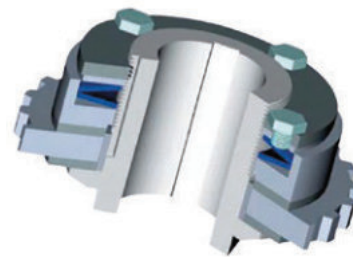

Fig. 4.5: Schematic representation of a slip clutch

#### 4.7 PISTON RETURN SPRINGS

Off-road and automotive transmission (Fig. 4.6)

The disc spring ensures that the hydraulically actuated piston returns to its original position after the load on the clutch is released. Tolerances and wear on the clutch components are compensated for by the horizontal characteristic of the load curve in the working range of the disc spring. This results in consistent shift quality.



Fig. 4.6: Schematic representation of a piston return assembly

#### 4.8 SPRING-ACTUATED BRAKES (FAIL SAFE BRAKES)

Plant construction, machine construction, motor vehicle construction (Fig. 4.7)

The braking load is generated by the disc springs when the hydraulic pressure is reduced to a predetermined level.

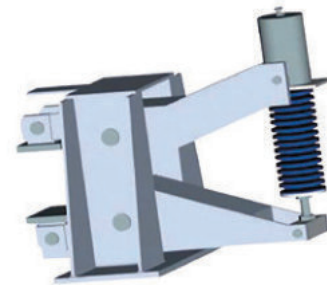

Fig. 4.7: Schematic representation of a safety brake

#### 4.9 TOOL CLAMPING COMPONENTS

Machine construction, toolmaking (Fig. 4.8)

In tool clamping components, the function of the disc spring stack is to hold the tool securely in the tapered holder.



Fig. 4.8: Schematic representation of a tool clamping component

#### 4.10 BACKLASH COMPENSATION

Plant construction, machine construction, motor vehicle construction (Fig. 4.9)

Disc springs are often used to compensate for geometric tolerance in component assemblies.

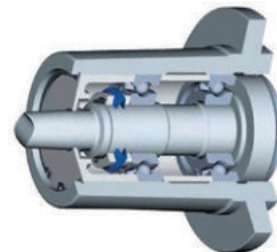
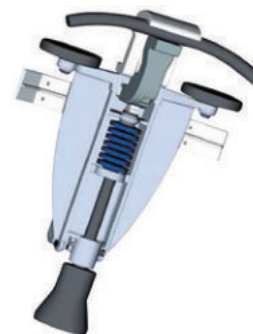

Fig. 4.9: Schematic representation of a backlash compensation

#### 4.11 CABLEWAY GRIP

Plant construction (Fig. 4.10)

On cableways a disc spring stack generates a friction lock between the cable grip and the wire cable. Depending on the type of grip, the load can be static or dynamic.



4.10: Schematic representation of a cableway grip

# 5 MANUFACTURING

## 5.1 SERIES PRODUCTION PROCESS STEPS

### 5.1.1 STAMPING / FINE BLANKING (GROUP 1, 2)

In the Attendorn parent plant, Mubea has its own cold rolling mill, which is equipped with modern “Quarto” mills for producing cold-rolled strip of the highest precision. In high-convection hydrogen annealing, the material is annealed for the achievement of very homogeneous material properties. This creates the suitable precondition for the initial manufacturing step for the production of disc springs stamping or fine blanking.

Conventional stamping is used for material thicknesses below 1.25mm (group 1 according to DIN EN 16983 (former DIN 2093)).

With low material thicknesses, the process together with the edge rounding in combination with the surface grinding provides a cut surface quality that is suitable for most requirements and at the same time is very economical.

For the manufacture of disc springs with particularly high demands on shape and position tolerances as well as for disc springs that are particularly sensitive to hardness distortion due to their geometry, the Mubea machinery with modern punching presses and years of experience in Mubea toolmaking allow the use of pre-coated strip material without sacrificing service life.

For the production of medium-sized disc springs (group 2 according to DIN EN 16983 (former DIN 2093)), Mubea relies on fineblanking which in addition to the tight geometrical tolerances of the disc blanks, enables a very good cut surface quality with very good economy.

Mubea has a vast machine park with fine blanking machines that can apply up to 1,000 tons of pressing force. All tools needed for the stamping or fine blanking are designed and built in Mubea’s in-house tool construction. In addition to the great know-how in the fine blanking sector, Mubea impresses here with high flexibility, even for very complex cutting geometries, as well as cost-effective production of tools.



### 5.1.2 PLASMA CUTTING (GROUP 3)

For disc springs with a thickness greater 6 mm (group 3 acc. DIN EN 16983 (former DIN 2093)), Mubea relies on plasma cutting, which enables flexible manufacture of various spring diameters with simultaneously high efficiency from flat-rolled heavy plate. The required homogeneous material characteristics are set for the following processes via a subsequent soft annealing of the spring plates.

---

### 5.1.3 DE-BURRING (GROUP 1, 2)

The burr produced in stamping or fine blanking must be removed by subsequent de-burring. This occurs either on modern centrifugal force grinding machines for small and medium spring diameters or in round vibrators for greater dimensions. Delicate spring geometries can be de-burred on specific brushing units without delay. Therefore, Mubea is best equipped for all spring geometries in order to ensure complete burr removal for the respective spring geometries.



### 5.1.4 FORMING (GROUP 1, 2, 3)

Before the spring blanks can be supplied for machining or tempering, they must first be brought into a conical plate shape. Mubea has a wide range of different presses for forming the flat blanks. Especially for parts with large quantities, fully automated systems with camera sensor technology are used.

---

### 5.1.5 TURNING (GROUP 3)

The annealed spring blanks must be machined on all sides in order to ensure a high surface quality for later use. For this purpose, efficient automatic machining devices are used with which the narrowest geometric tolerances are set. The machine park ensures the manufacture of many different spring designs with simultaneously short cycle times.

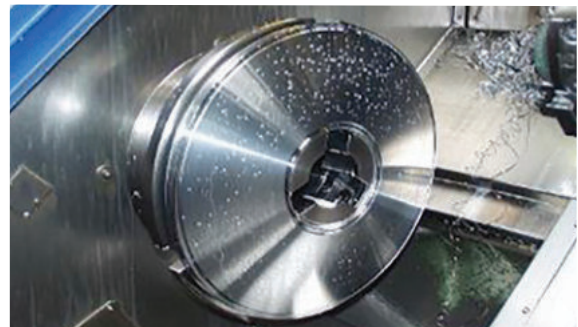

### 5.1.6 HARDENING AND TEMPERING (GROUP 1,2,3)

The core process for setting the optimum material properties of the disc spring is hardening and tempering. Small and medium-sized springs are hardened and tempered using bainitic or martensitic hardening in ultra-modern continuous furnaces in order to ensure the best material properties. Chamber furnaces having specific furnace atmospheres that ensure reliable through-hardening of large disc springs. In this way, the potential of the materials used is optimal for setting the spring characteristics. The recovery of the salt in the bainitic hardening and tempering is a contribution for the protection of the environment at Mubea.



### 5.1.7 SHOT PEENING (GROUP 1,2,3)

The shot peening is an established and also economical procedure for applying residual compressive stresses and, thus, for significantly improving the lifetime of springs. In the manufacture of disc springs, shot-peening is a standard in-house process at Mubea. Depending on their spring geometry, the disc springs are treated either as bulk goods in drum blasting machines or as individual springs on appropriate single jet machines. The monitoring of the blast parameters that accompanies the process ensures optimum blast properties for reliable attainment of long spring lifetime.

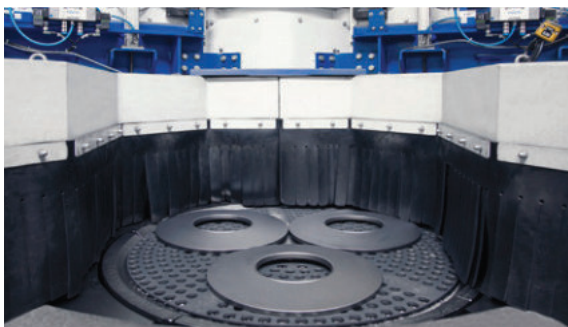

### 5.1.8 DEEP ROLLING

The deep rolling of disc springs for achieving the maximum service life, which is patent-protected by Mubea, is done on ultra-modern precisely controlled manufacturing lines. They are capable of very specifically deep-rolling spring geometries up to 500 mm outer diameter in order to exploit the enormous potential of this technology.

### 5.1.9 PRE-SETTING

The disc springs in use should work in an elastic manner, just as is required in DIN EN 16983 (former DIN 2093) . To do this, the individual springs should be compressed at least down to the flat position at the end of their manufacture. At Mubea this is done on part-specific pre-setting machines; often after the automated pre-setting of the springs, a 100% check for setting narrow force tolerances is arranged downstream. Also, it exists the possibility of presenting an individual pre-setting of the individual springs with 100 % load testing. In this way, the narrowest spring force tolerances are realized, for example, for the use in clutches and brakes.

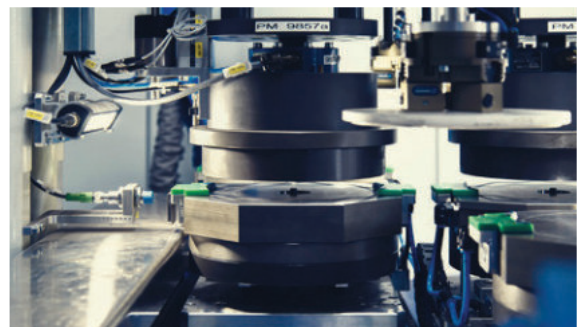



### 5.1.9 PHOSPHATIZING

At Mubea zinc phosphatizing and oiling is used as standard corrosion protection. For this purpose, Mubea has a computer-controlled continuous flow system in which, along with the phosphatizing of the surface for certain parts, oiling is arranged downstream for a number of different corrosion requirements.



### 5.1.10 STACK DESIGN

Customers, especially in machine and system construction, often require pre-assembled and force-tested spring stacks. Mubea realizes this by provision of suitable test machines up to 1,600 kN of testing force. Mubea is also capable of providing housings for the guidance of spring stacks in its in-house production, for example, for applications in motor vehicle design.

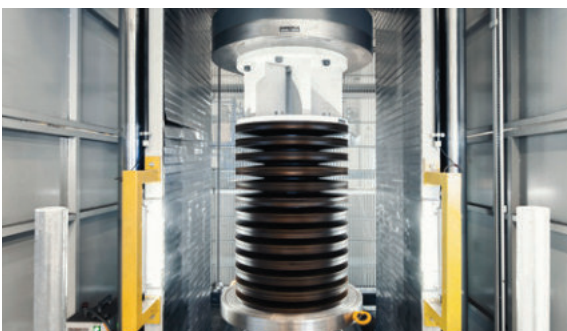

### 5.2 SAMPLE SHOP

For the manufacture of prototypes, Mubea has its own model design with extensive know-how with which it is also possible to produce complex springs with tight tolerances. Often systems from the series production process are used during the manufacture of the prototypes in order to attain knowledge for the subsequent series production process even in the early stage of part production. The service life testing of sample parts or series parts can be realized on hydropulsers with up to 500 kN of testing force.



# 6 QUALITY CONTROL / VALIDATION

In order to assure premium quality Mubea can rely on a broad range of calibrated testing equipment with excellently trained personal. Among this equipment are series-accompanying systems, which are interlinked with the digital CAQ to check dimensional tolerances, hardness and spring force. Moreover, the possibility exists to carry out fatigue tests with single springs as well as disc stacks on twenty in-house testing machines.

## 6.1 SERIES ACCOMPANYING TESTS

- Dimensional test  $D_e$ ,  $D_i$ ,  $t$ ,  $l_o$
- Hardness test Rockwell, Vickers, Brinell
- Load tester up to 1,600 kN
- Customer-specific tests
- Application-specific tests

For special applications, springs can be investigated by non-destructive methods for cracks and flaws. Measurements of residual magnetism and contours can also be carried out. For further investigations and sampling the internal measuring laboratory is accessible at a neighboring location with modern 3-D-coordinate-measuring systems. In addition, the Central Laboratory at the Company's Head Office in Attendorn is also available.



Fig. 6.1: Hardness test HRC



Fig. 6.2: Dimensional control

## 6.2 FATIGUE TESTING

- Life time test of single springs and disc spring stacks
- Maximum load up to 500 kN (1,600 kN)
- Test frequency up to 10 Hz
- Test temperature up to 90°C (150°C), in oil
- Customer-specific tests
- Application-specific tests



Fig. 6.2: Life time test of disc spring stacks

## 6.3 OTHER TESTINGS

- Crack detection
  - MPI (Magnetic Particle Inspection)
  - Dye penetrant testing
- Magnetic field strength measurement (residual magnetism)
- Contour measurement
- Residual dirt analysis
- Hardness profile measurement, small load hardness testing

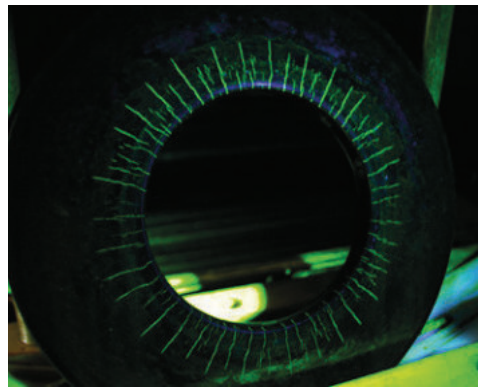

Fig. 6.3: Magnetic Particle Inspection

## 6.4 MATERIAL TESTS AND INVESTIGATIONS

Aside from the following tests, which can be performed in your own laboratory, Mubea works together with leading external laboratories and universities.

- Residual stress measurement
- Microstructural investigation
- SEM – Analysis
- Fracture analysis, etc.
- Corrosion tests (condensation water test acc. DIN EN ISO 6270-2 and salt spray test acc. DIN EN ISO 9227 NSS)



Fig. 6.4: 1,600 kN testing machine



# 7 TRENDS

---

Disc springs are used in nearly all areas of technology and accordingly perform completely different tasks. As the demands of the customers increase, so do also the requirements for the disc springs.

In the automobile area, measures for reduction of weight and structural space dominate in order to reduce the generation of CO<sub>2</sub> emissions, which are harmful to the environment. In the petroleum industry, the sensitivity for safety standards has clearly intensified, especially since the catastrophe of the Deepwater Horizon Platform in 2010 in the Gulf of Mexico. Mechanically impinged, compact spring systems are a significant factor here in order to prevent or at least reduce damage in the event of an emergency. In the energy sector, global capacities are being expanded; moreover, the share of renewable energies, such as wind energy, is steadily increasing. Similar trends with regard to structural space and quality are found again in general machine and plant design. For the spring manufacturer, three significant target values can be derived for the product disc springs: (1) high reliability, (2) an

increasingly compact design and (3) a continuing economic cost level. For the disc springs, these trends result in an increase in stress resistance with simultaneously increased reliability. Since 2008, Mubea has therefore already had the Generation II springs successfully in series production, which, due to a significant increase in the load, can substantially contribute to the realization of compact designs of the individual springs or spring stacks with equal or higher spring forces and in this way promote a reduction in system costs. This technology, in the meantime, is available for nearly all spring dimensions and is understood to be continually increasing. Parallel to this, efficient production processes with material and product properties having tight tolerances contribute to improved quality and cost attributes.

Therefore, because of its versatility and continuous improvement, there is nothing in the way of a prosperous future for the innovative product “disc spring”.

# 8 LITERATURE

---

## 8.1 LITERATURE

## 8.2 LAWS, STANDARDS, GUIDELINES

[DIN EN 16984 (former DIN 2092)]

Disc spring calculation

[DIN EN 16983 (former DIN 2093)]

Disc spring quality requirements – dimensions

[DIN EN 10083]

Quenched and tempered steel – Part 1:  
General technical conditions of supply

[DIN EN 10132-4]

Cold-rolled strip made of steel for a heat  
treatment; Technical conditions of supply  
Part 4: Spring steels and other applications

[DIN EN 10089]

Hot-rolled steels for heat-treatable springs –  
Technical conditions of supply

[DIN EN 10088-2]

Corrosion-resistant steels – Part 2:  
Technical conditions of supply for sheet and strip  
from corrosion-resistant steels for general use

# I GLOSSARY

## I.I LATEINISCHE SYMBOLE

$D_e$	outer diameter .....	[mm]
$D_i$	inner diameter .....	[mm]
$E$	modulus of elasticity.....	[N/mm <sup>2</sup> ]
$F$	spring force.....	[N]
$F_1, F_2, F_3, \dots$	spring force rel. to spring deflection $s_1, s_2, s_3, \dots$ .....	[N]
$F_c$	spring force rel. to flat position.....	[N]
$F_{ges}$	total spring force.....	[N]
$h_0$	spring deflection from free height to flat position .....	[mm]
$i$	amount of disc springs arranged in spring packs.....	[ ]
$l_0$	spring height .....	[mm]
$\Delta l$	Loss of length due to creep .....	[mm]
$L_0$	length of spring stack/spring pack .....	[mm]
$L_1, L_2, L_3, \dots$	spring height rel. to spring force $F_1, F_2, F_3, \dots$ .....	[mm]
$L_c$	contact length.....	[mm]
$N$	load cycles .....	[ ]
$n$	amount of disc springs arranged in spring stacks.....	[ ]
$M$	spring mass .....	[g]
$R_a$	arithmetical mean deviation .....	[ $\mu$ m]
$s$	spring deflection .....	[mm]
$S, S_0$	center of inversion .....	[ ]
$s_c$	spring deflection rel. to flat position .....	[mm]
$s_{tot}$	total spring deflection .....	[mm]
$s_u$	preload distance.....	[mm]
$t$	material thickness.....	[mm]
$T$	total clearance.....	[mm]
( )'	All values marked with an ' ie. $F', s', h_0', t', d_e', d_i'$ etc. refer to disc springs with contact surface	

## I.II GREEK SYMBOLS

$\mu$	Poisson ratio.....	[ ]
$\mu_M, \mu_R$	COULOMB's coefficients of friction .....	[ ]
$\sigma_a$	stress amplitude .....	[N/mm <sup>2</sup> ]
$\sigma_I, \sigma_{II}, \sigma_{III}, \sigma_{IV}$	calculated stresses at edge I, II, III, IV .....	[N/mm <sup>2</sup> ]
$\sigma_{Ic}$	max. perm. stress at edge I.....	[N/mm <sup>2</sup> ]
$\sigma_H$	elevation stress.....	[N/mm <sup>2</sup> ]
$\sigma_{max}$	max. stress.....	[N/mm <sup>2</sup> ]
$\sigma_t$	torsion stress .....	[N/mm <sup>2</sup> ]
$\sigma_u$	min. stress.....	[N/mm <sup>2</sup> ]
$\phi_0$	cone angle.....	[°]

# II FIGURES AND TABLES

## II.1 LIST OF FIGURES

Fig. 2.1:	Service life comparison.....	10
Fig. 2.2:	Second Generation disc springs.....	11
Fig. 3.1:	Single disc spring.....	12
Fig. 3.2:	Typical load curve.....	12
Fig. 3.3:	Disc spring stack.....	12
Fig. 3.4:	Disc spring pack.....	12
Fig. 3.5:	Various disc spring combination (left), progressive load curve (right).....	13
Fig. 3.6:	Group 1 + 2 without contact surfaces (left), Group 3 with contact surfaces (right).....	14
Fig. 3.7:	Possible load characteristics.....	15
Fig. 3.8:	Theoretical load curve.....	16
Fig. 3.9:	Superimposing stresses and residual stresses result in total stresses.....	17
Fig. 3.10:	Dimensional relationship when load is applied via a shortened lever arm.....	18
Fig. 3.11:	Comparison of disc spring with (left) and without contact surfaces (right).....	18
Fig. 3.12:	Comparison of the calculated characteristic curves of disc springs with and without contact surfaces.....	19
Fig. 3.13:	Spring stack out of n individual springs.....	20
Fig. 3.14:	Series spring stack consisting of i individual disc springs.....	20
Fig. 3.15:	Spring stacks with progressive load curve and stroke limiters (a) bell, b) stop).....	21
Fig. 3.16:	Different types of spring stack guides.....	22
Fig. 3.17:	Spring stack guides (left); Total clearances (right).....	23
Fig. 3.18:	Representation of motion as a function of time during dynamic loading.....	24
Fig. 3.19:	Fatigue strength diagram for $N = 2 \cdot 10^6$ load cycles.....	26
Fig. 3.20:	Wöhler diagrams showing comparison between Mubea and DIN EN 16983 (former DIN 2093) ..	27
Fig. 3.21:	Permissible relaxation of disc springs.....	28
Fig. 3.22:	Individual disc spring with edge friction: a) Overall view b) Compression c) Extension.....	29
Fig. 3.23:	Friction forces on a parallel stack of disc springs.....	29
Fig. 3.24:	Comparison of measured and calculated characteristics load curves for an individual disc spring and a parallel stack comprised of 2 to 4 disc springs.....	30
Fig. 3.25:	Deflection of individual disc springs in a series stack.....	31
Fig. 3.26:	Comparison between the measured and the calculated characteristic load curves for a spring stack consisting of 10 springs arranged.....	31

Fig. 4.1:	Schematic representation of a disc spring stack in a guide cage.....	46
Fig. 4.2:	Schematic representation of a safety valve.....	46
Fig. 4.3:	Schematic representation of an energy storage system with springs .....	46
Fig. 4.4:	Schematic representation of an overload clutch .....	47
Fig. 4.5:	Schematic representation of a slip clutch.....	47
Fig. 4.6:	Schematic representation of a piston return assembly.....	47
Fig. 4.7:	Schematic representation of a safety brake.....	48
Fig. 4.8:	Schematic representation of a tool clamping component.....	48
Fig. 4.9:	Schematic representation of a backlash compensation.....	48
Fig. 4.10:	Schematic representation of a cableway grip .....	48
Fig. 6.1:	Hardness test HRC.....	53
Fig. 6.2:	Life time test of disc spring stacks.....	53
Fig. 6.3:	Magnetic Particle Inspection .....	54
Fig. 6.4:	1600 kN testing machine.....	54

## II.II TABLES

Tab. 3.1:	Production method and permissible surface finish .....	14
Tab. 3.2:	Maximum permissible stresses in the flat condition .....	24
Tab. 3.3:	Allowable tolerances for material thickness, free height, spring force .....	32
Tab. 3.4:	Allowable tolerances for material thickness, free height, spring force and spring hardness .....	33
Tab. 3.5:	Overview of materials .....	34-35
Tab. 3.6:	Overview Corrosion Protection .....	40-41
Tab. 4.1:	Product overview .....	45
Tab. III:	Disc Springs according to DIN and Mubea standard .....	60-79
Tab. III.1:	Mubea disc springs made from corrosion resistant materials .....	80-83

# III STANDARD DIMENSIONS

## STANDARD DIMENSIONS ACCORDING TO DIN EN 16983 (FORMER DIN 2093) AND MUBEA STANDARDS

Part No.	DIN Series	not on Stock	Dimensions in mm							spring deflection s in mm					spring force F in N	
										s = 0,25 h <sub>0</sub>					s = 0,5 h <sub>0</sub>	
			D <sub>e</sub>	D <sub>i</sub>	t	t'	l <sub>0</sub>	h <sub>0</sub>	h <sub>0</sub> /t	s	F	σ <sub>I</sub>	σ <sub>II</sub>	σ <sub>III</sub>	s	F
17 0001			8,0	3,20	0,30		0,55	0,25	0,833	0,062	45,6	883	207	401	0,125	79,1
17 0002			8,0	3,20	0,40		0,60	0,20	0,500	0,050	69,2	797	365	350	0,100	130,1
17 0003			8,0	3,20	0,50		0,70	0,20	0,400	0,050	128,4	943	511	408	0,100	246,4
17 0004	C		8,0	4,20	0,20		0,45	0,25	1,250	0,062	21,2	696	8	409	0,125	33,3
17 0005	B		8,0	4,20	0,30		0,55	0,25	0,833	0,062	51,6	872	184	501	0,125	89,3
17 0006	A		8,0	4,20	0,40		0,60	0,20	0,500	0,050	78,2	784	343	439	0,100	147,0
17 0007			10,0	3,20	0,30		0,65	0,35	1,166	0,087	51,1	979	90	378	0,175	81,6
17 0008			10,0	3,20	0,40		0,70	0,30	0,750	0,075	75,1	938	285	348	0,150	132,9
17 0009			10,0	3,20	0,50		0,85	0,35	0,700	0,087	165,3	1336	447	492	0,175	296,1
17 0010			10,0	4,20	0,40		0,70	0,30	0,750	0,075	79,3	860	241	405	0,150	140,3
17 0011			10,0	4,20	0,50		0,75	0,25	0,500	0,062	109,8	789	359	361	0,125	206,3
17 0012			10,0	4,20	0,60		0,85	0,25	0,416	0,062	181,5	904	473	410	0,125	347,2
17 0013	C		10,0	5,20	0,25		0,55	0,30	1,200	0,075	30,4	654	21	380	0,150	48,2
17 0014	B		10,0	5,20	0,40		0,70	0,30	0,750	0,075	87,8	857	224	485	0,150	155,3
17 0015	A		10,0	5,20	0,50		0,75	0,25	0,500	0,062	121,5	782	343	435	0,125	228,3
17 0016			12,0	4,20	0,40		0,80	0,40	1,000	0,100	85,1	936	149	385	0,200	141,4
17 0017			12,0	4,20	0,50		0,90	0,40	0,800	0,100	142,6	1072	285	432	0,200	249,0
17 0018			12,0	4,20	0,60		1,00	0,40	0,666	0,100	224,1	1208	421	480	0,200	404,9
17 0019			12,0	5,20	0,50		0,90	0,40	0,800	0,100	150,4	1015	251	493	0,200	262,7
17 0020			12,0	5,20	0,60		0,95	0,35	0,583	0,087	195,9	957	372	455	0,175	361,2
17 0021			12,0	6,20	0,50		0,85	0,35	0,700	0,087	133,5	845	249	475	0,175	239,2
17 0022			12,0	6,20	0,60		0,95	0,35	0,583	0,087	213,6	955	358	531	0,175	393,8
17 0023	C		12,5	6,20	0,35		0,80	0,45	1,285	0,112	83,5	903	2	506	0,225	129,8
17 0024	B		12,5	6,20	0,50		0,85	0,35	0,700	0,087	120,0	775	231	420	0,175	215,1
17 0025	A		12,5	6,20	0,70		1,00	0,30	0,428	0,075	239,4	804	403	425	0,150	456,8
17 0026			14,0	7,20	0,35		0,80	0,45	1,285	0,112	68,0	723	-11	418	0,225	105,7
17 0027			14,0	7,20	0,50		0,90	0,40	0,800	0,100	120,1	745	173	419	0,200	209,8
17 0028			14,0	7,20	0,80		1,10	0,30	0,375	0,075	283,8	712	390	386	0,150	547,2
17 0029			15,0	5,20	0,40		0,95	0,55	1,375	0,137	101,2	957	3	401	0,275	154,4
17 0030			15,0	5,20	0,50		1,00	0,50	1,000	0,125	132,8	939	151	383	0,250	220,6
17 0031			15,0	5,20	0,60		1,05	0,45	0,750	0,112	170,8	908	269	361	0,225	302,1
17 0032			15,0	5,20	0,70		1,25	0,55	0,785	0,137	340,2	1317	362	526	0,275	596,4

\*\*)  $sc = h_0 = l_0 - t$  for disc springs without contact surfaces  
 $sc = h_0 = l_0 - t'$  for disc springs with contact surfaces

spring force F in N			stress $\sigma$ in N/mm <sup>2</sup>					$s_c^{**}$					Weight
$s = 0,5 h_0$			$s = 0,75 h_0$										1.000 pcs.
$\sigma_I$	$\sigma_{II}$	$\sigma_{III}$	s	F	$\sigma_I$	$\sigma_{II}$	$\sigma_{III}$	s	F	$\sigma_I$	$\sigma_{II}$	$\sigma_{III}$	in kg
1669	511	750	0,187	104,3	2359	912	1046	0,250	125,5	2952	1409	1290	0,099
1533	792	666	0,150	185,5	2207	1281	949	0,200	238	2820	1832	1198	0,133
1824	1083	782	0,150	357,4	2643	1717	1123	0,200	464,9	3401	2413	1430	0,166
1294	114	753	0,187	39,2	1794	319	1034	0,250	42	2195	622	1251	0,057
1646	467	938	0,187	117,9	2322	847	1312	0,250	141,8	2900	1326	1620	0,086
1504	749	837	0,150	209,5	2162	1218	1194	0,200	268,9	2757	1750	1511	0,114
1831	308	697	0,262	98,3	2556	652	957	0,350	108	3154	1123	1158	0,166
1782	663	652	0,225	179,1	2533	1134	913	0,300	219,6	3191	1698	1130	0,221
2544	1021	925	0,262	404,0	3626	1721	1299	0,350	500,4	4580	2549	1614	0,277
1632	570	760	0,225	189,1	2316	988	1066	0,300	231,8	2911	1495	1322	0,203
1516	778	688	0,187	294,0	2182	1260	981	0,250	377,3	2786	1803	1239	0,254
1746	1008	785	0,187	502,3	2526	1604	1125	0,250	652	3245	2262	1432	0,304
1217	133	702	0,225	57,5	1691	336	965	0,300	62,6	2074	628	1169	0,112
1623	539	912	0,225	209,3	2299	943	1281	0,300	256,5	2884	1439	1591	0,180
1502	749	829	0,187	325,3	2159	1218	1182	0,250	417,5	2753	1749	1495	0,225
1760	411	714	0,300	178,3	2472	786	988	0,400	205,6	3071	1272	1205	0,311
2032	683	809	0,300	331,4	2879	1193	1130	0,400	401,7	3614	1815	1395	0,389
2303	954	904	0,300	556,8	3286	1600	1273	0,400	694,1	4157	2358	1585	0,467
1921	611	923	0,300	349,6	2717	1080	1291	0,400	423,8	3404	1658	1596	0,360
1830	828	863	0,262	506,1	2620	1367	1222	0,350	640,7	3326	1990	1534	0,432
1605	582	894	0,262	326,4	2280	1001	1259	0,350	404,2	2869	1506	1569	0,325
1824	801	1007	0,262	551,7	2608	1329	1429	0,350	698,5	3307	1943	1795	0,390
1677	134	932	0,337	151,2	2323	393	1278	0,450	160,2	2840	782	1542	0,254
1473	539	791	0,262	293,4	2093	925	1114	0,350	363,4	2635	1389	1388	0,363
1550	864	814	0,225	659,5	2240	1382	1167	0,300	854,9	2872	1957	1484	0,508
1343	103	770	0,337	123,2	1860	309	1055	0,450	130,5	2273	619	1274	0,311
1408	428	787	0,300	279,2	1990	764	1101	0,400	338,4	2490	1182	1363	0,444
1377	826	743	0,225	796,8	1997	1308	1071	0,300	1040	2571	1836	1369	0,711
1777	142	735	0,412	175,5	2462	417	1002	0,550	180,7	3010	828	1202	0,488
1766	414	711	0,375	278,2	2480	790	983	0,500	320,9	3082	1279	1199	0,610
1725	630	678	0,337	407,2	2451	1082	949	0,450	499	3085	1625	1176	0,732
2497	861	985	0,412	796,5	3541	1496	1376	0,550	968,6	4449	2268	1701	0,854

Tab. III: Disc Springs according to DIN and Mubea standard

STANDARD DIMENSIONS ACCORDING TO DIN EN 16983 (FORMER DIN 2093) AND MUBEA STANDARDS

Part No.	DIN Series	not on Stock	Dimensions in mm							spring deflection s in mm					spring force F in N	
			D <sub>e</sub>	D <sub>i</sub>	t	t'	l <sub>0</sub>	h <sub>0</sub>	h <sub>0</sub> /t	s = 0,25 h <sub>0</sub>					s = 0,5 h <sub>0</sub>	
										s	F	σ <sub>I</sub>	σ <sub>II</sub>	σ <sub>III</sub>	s	F
17 0033			15,0	6,20	0,50		1,00	0,50	1,000	0,125	138,1	895	129	424	0,250	229,4
17 0034			15,0	6,20	0,60		1,05	0,45	0,750	0,112	177,6	863	243	400	0,225	314,2
17 0035			15,0	6,20	0,70		1,10	0,40	0,571	0,100	222,4	818	328	373	0,200	411,1
17 0036			15,0	8,20	0,70		1,10	0,40	0,571	0,100	256,3	819	311	479	0,200	473,9
17 0037			15,0	8,20	0,80		1,20	0,40	0,500	0,100	366,8	900	391	523	0,200	689,3
17 0038	C		16,0	8,20	0,40		0,90	0,50	1,250	0,125	83,7	693	10	399	0,250	131,2
17 0039	B		16,0	8,20	0,60		1,05	0,45	0,750	0,112	172,0	751	197	420	0,225	304,3
17 0040	A		16,0	8,20	0,90		1,25	0,35	0,388	0,087	362,5	721	386	391	0,175	697,0
17 0041			18,0	6,20	0,40		1,00	0,60	1,500	0,150	84,6	759	-30	319	0,300	126,1
17 0042			18,0	6,20	0,50		1,10	0,60	1,200	0,150	129,9	851	61	350	0,300	205,7
17 0043			18,0	6,20	0,60		1,20	0,60	1,000	0,150	191,1	942	152	382	0,300	317,3
17 0044			18,0	6,20	0,70		1,40	0,70	1,000	0,175	354,1	1282	207	520	0,350	588,0
17 0045			18,0	6,20	0,80		1,50	0,70	0,875	0,175	479,5	1388	313	556	0,350	821,6
17 0046			18,0	8,20	0,70		1,25	0,55	0,785	0,137	254,6	858	216	434	0,275	446,2
17 0047			18,0	8,20	0,80		1,30	0,50	0,625	0,125	308,9	823	292	411	0,250	563,8
17 0048			18,0	8,20	1,00		1,50	0,50	0,500	0,125	559,0	963	432	475	0,250	1051,0
17 0049	C		18,0	9,20	0,45		1,05	0,60	1,333	0,150	120,7	763	-14	440	0,300	185,8
17 0050	B		18,0	9,20	0,70		1,20	0,50	0,714	0,125	233,4	756	216	421	0,250	416,6
17 0051	A		18,0	9,20	1,00		1,40	0,40	0,400	0,100	450,6	728	382	394	0,200	865,0
17 0052			20,0	8,20	0,50		1,15	0,65	1,300	0,162	128,3	739	11	355	0,325	198,8
17 0053			20,0	8,20	0,60		1,30	0,70	1,166	0,175	214,4	907	63	432	0,350	342,1
17 0054			20,0	8,20	0,70		1,35	0,65	0,928	0,162	261,5	890	161	416	0,325	442,0
17 0055			20,0	8,20	0,80		1,40	0,60	0,750	0,150	315,0	865	244	398	0,300	557,3
17 0056			20,0	8,20	0,90		1,50	0,60	0,666	0,150	423,2	934	313	427	0,300	764,5
17 0057			20,0	8,20	1,00		1,60	0,60	0,600	0,150	555,6	1003	382	455	0,300	1020,0
17 0058			20,0	10,20	0,40		0,90	0,50	1,250	0,125	53,4	443	6	254	0,250	83,7
17 0059	C		20,0	10,20	0,50		1,15	0,65	1,300	0,162	141,3	734	-4	422	0,325	218,9
17 0060	B		20,0	10,20	0,80		1,35	0,55	0,687	0,137	304,3	759	230	421	0,275	546,8
17 0061			20,0	10,20	0,90		1,45	0,55	0,611	0,137	411,7	821	292	452	0,275	754,0
17 0062			20,0	10,20	1,00		1,55	0,55	0,550	0,137	543,6	882	354	484	0,275	1010,0
17 0063	A		20,0	10,20	1,10		1,55	0,45	0,409	0,112	548,2	733	379	397	0,225	1050,0
17 0064			22,5	11,20	0,60		1,40	0,80	1,330	0,200	240,4	865	-14	488	0,400	369,9
17 0065			22,5	11,20	0,80		1,45	0,65	0,812	0,162	306,3	751	171	412	0,325	533,4
18 0001			22,5	11,20	1,25		1,75	0,50	0,400	0,125	693,1	726	383	384	0,250	1330,0
17 0066			23,0	8,20	0,70		1,50	0,80	1,142	0,200	279,4	940	87	397	0,400	448,4
17 0067			23,0	8,20	0,80		1,55	0,75	0,937	0,187	332,0	925	175	384	0,375	560,0
17 0068			23,0	8,20	0,90		1,70	0,80	0,888	0,200	485,7	1086	233	449	0,400	829,2
17 0069			23,0	10,20	0,90		1,65	0,75	0,833	0,187	463,1	944	213	469	0,375	801,9
17 0070			23,0	10,20	1,00		1,70	0,70	0,700	0,175	538,2	919	282	451	0,350	964,2
17 0071			23,0	12,20	1,00		1,60	0,60	0,600	0,150	474,7	753	271	429	0,300	871,7
18 0002			23,0	12,20	1,25		1,85	0,60	0,480	0,150	863,4	881	399	497	0,300	1630,0
18 0003			23,0	12,20	1,50		2,10	0,60	0,400	0,150	1432,0	1009	527	565	0,300	2748,0

\*\*)  $sc = h_0 = l_0 - t$  for disc springs without contact surfaces  
 $sc = h_0 = l_0 - t'$  for disc springs with contact surfaces



spring force F in N			stress $\sigma$ in N/mm <sup>2</sup>					$s_c^{**}$						Weight
$s = 0,5 h_0$			$s = 0,75 h_0$											1.000 pcs.
$\sigma_I$	$\sigma_{II}$	$\sigma_{III}$	s	F	$\sigma_I$	$\sigma_{II}$	$\sigma_{III}$	s	F	$\sigma_I$	$\sigma_{II}$	$\sigma_{III}$	in kg	
1680	368	787	0,375	289,4	2356	716	1089	0,500	333,7	2923	1173	1331	0,575	
1638	574	752	0,337	423,5	2323	994	1054	0,450	519	2921	1503	1307	0,690	
1567	727	707	0,300	577,5	2245	1195	1002	0,400	732,6	2854	1734	1258	0,805	
1566	694	909	0,300	665,6	2240	1150	1291	0,400	844,4	2841	1679	1624	0,681	
1727	856	997	0,300	982,3	2482	1392	1423	0,400	1261	3164	2002	1800	0,778	
1289	117	735	0,375	154,3	1786	322	1009	0,500	165,4	2186	624	1220	0,465	
1423	474	790	0,337	410,0	2016	830	1109	0,450	502,5	2530	1264	1377	0,698	
1394	820	751	0,262	1013,0	2019	1301	1080	0,350	1319	2596	1831	1379	1,047	
1406	52	583	0,450	138,6	1940	247	791	0,600	136,7	2361	555	944	0,704	
1588	234	646	0,450	245,4	2213	520	885	0,600	267	2725	920	1070	0,880	
1770	416	708	0,450	400,3	2486	794	980	0,600	461,6	3090	1284	1195	1,056	
2410	567	964	0,525	741,7	3384	1080	1333	0,700	855,2	4205	1748	1627	1,232	
2622	779	1037	0,525	1072,0	3703	1399	1443	0,700	1277	4630	2173	1774	1,408	
1624	523	815	0,412	596,0	2298	922	1141	0,550	724,7	2881	1413	1412	1,108	
1570	660	777	0,375	782,6	2242	1104	1098	0,500	983,5	2837	1624	1375	1,266	
1849	939	904	0,375	1497,0	2660	1523	1289	0,500	1921	3395	2182	1629	1,582	
1415	83	809	0,450	213,7	1957	291	1106	0,600	222,9	2387	610	1333	0,664	
1434	509	792	0,375	566,4	2035	879	1114	0,500	699,4	2560	1326	1387	1,033	
1406	814	757	0,300	1254,0	2035	1295	1088	0,400	1631	2615	1826	1387	1,476	
1375	126	652	0,487	230,8	1906	345	892	0,650	243,4	2333	668	1074	1,026	
1694	246	797	0,525	412,0	2360	550	1095	0,700	453	2905	974	1327	1,231	
1675	426	775	0,487	568,5	2356	795	1076	0,650	668	2934	1269	1320	1,436	
1640	576	748	0,450	751,0	2328	998	1048	0,600	920,5	2926	1507	1300	1,641	
1779	715	804	0,450	1051,0	2535	1205	1133	0,600	1311	3203	1784	1413	1,846	
1917	853	861	0,450	1424,0	2743	1413	1218	0,600	1798	3480	2062	1527	2,051	
824	75	468	0,375	98,5	1142	206	642	0,500	105,5	1398	400	777	0,730	
1363	98	776	0,487	254,1	1887	305	1063	0,650	268	2305	617	1283	0,912	
1442	536	793	0,412	748,2	2050	917	1118	0,550	929	2582	1374	1394	1,460	
1566	659	856	0,412	1050,0	2235	1102	1212	0,550	1323	2829	1621	1520	1,642	
1689	783	920	0,412	1425,0	2421	1288	1307	0,550	1815	3077	1868	1646	1,824	
1416	809	761	0,337	1521,0	2048	1290	1093	0,450	1976	2630	1821	1393	2,007	
1605	98	897	0,600	425,4	2219	336	1227	0,800	443,9	2708	699	1478	1,409	
1420	425	771	0,487	707,4	2006	762	1079	0,650	855,1	2508	1182	1335	1,878	
1403	815	737	0,375	1929,0	2031	1296	1059	0,500	2509	2610	1825	1350	2,935	
1758	295	733	0,600	543,6	2454	626	1007	0,800	601,9	3028	1078	1221	1,993	
1743	457	714	0,562	718,5	2453	846	991	0,750	842,4	3057	1343	1214	2,277	
2051	589	837	0,600	1078,0	2894	1066	1164	0,800	1279	3615	1665	1430	2,561	
1784	531	877	0,562	1058,0	2520	953	1225	0,750	1273	3151	1480	1512	2,357	
1746	655	849	0,525	1315,0	2483	1119	1195	0,700	1629	3129	1673	1487	2,619	
1436	612	813	0,450	1217,0	2052	1020	1152	0,600	1536	2598	1498	1446	2,343	
1692	868	949	0,450	2331,0	2436	1404	1356	0,600	3000	3110	2010	1718	2,929	
1948	1124	1085	0,450	3986,0	2820	1788	1560	0,600	5184	3622	2522	1990	3,514	

Tab. III: Disc Springs according to DIN and Mubea standard

STANDARD DIMENSIONS ACCORDING TO DIN EN 16983 (FORMER DIN 2093) AND MUBEA STANDARDS

Part No.	DIN Series	not on Stock	Dimensions in mm							spring deflection s in mm					spring force F in N	
			D <sub>e</sub>	D <sub>i</sub>	t	t'	l <sub>0</sub>	h <sub>0</sub>	h <sub>0</sub> /t	s = 0,25 h <sub>0</sub>					s = 0,5 h <sub>0</sub>	
										s	F	σ <sub>I</sub>	σ <sub>II</sub>	σ <sub>III</sub>	s	F
17 0072	C		25,0	12,20	0,70		1,60	0,90	1,285	0,255	331,2	902	4	499	0,450	514,6
17 0073	B		25,0	12,20	0,90		1,60	0,70	0,777	0,175	366,8	724	181	389	0,350	644,3
18 0004	A		25,0	12,20	1,50		2,05	0,55	0,366	0,137	1040,0	761	425	393	0,275	2007,0
17 0074			28,0	10,20	0,80		1,75	0,95	1,187	0,237	347,9	870	62	375	0,475	552,5
17 0075			28,0	10,20	1,00		2,00	1,00	1,000	0,250	615,2	1061	165	451	0,500	1022,0
18 0005			28,0	10,20	1,25		2,25	1,00	0,800	0,250	1030,0	1214	319	507	0,500	1799,0
18 0006			28,0	10,20	1,50		2,20	0,70	0,466	0,175	1003,0	863	424	346	0,350	1899,0
17 0076			28,0	12,20	1,00		1,95	0,95	0,950	0,237	589,9	947	156	467	0,475	991,7
18 0007			28,0	12,20	1,25		2,10	0,85	0,680	0,212	843,8	934	300	451	0,425	1519,0
18 0008			28,0	12,20	1,50		2,25	0,75	0,500	0,187	1149,0	900	406	426	0,375	2159,0
17 0077	C		28,0	14,20	0,80		1,80	1,00	1,250	0,250	434,8	904	13	515	0,500	681,0
17 0078	B		28,0	14,20	1,00		1,80	0,80	0,800	0,200	476,4	744	174	414	0,400	832,0
18 0009			28,0	14,20	1,25		2,10	0,85	0,680	0,212	907,4	931	287	513	0,425	1634,0
18 0010	A		28,0	14,20	1,50		2,15	0,65	0,433	0,162	1033,0	747	371	403	0,325	1970,0
17 0079	C		31,5	16,30	0,80		1,85	1,05	1,312	0,262	384,3	771	-9	448	0,525	593,8
18 0011	B		31,5	16,30	1,25		2,15	0,90	0,720	0,225	790,5	797	224	449	0,450	1409,0
18 0012			31,5	16,30	1,50		2,40	0,90	0,600	0,225	1260,0	899	326	501	0,450	2314,0
18 0013			31,5	16,30	1,75		2,45	0,70	0,400	0,175	1391,0	729	382	399	0,350	2669,0
18 0014			31,5	16,30	2,00		2,75	0,75	0,375	0,187	2199,0	879	481	480	0,375	4239,0
17 0080			34,0	12,30	1,00		2,20	1,20	1,200	0,300	587,2	938	63	403	0,600	930,0
18 0015			34,0	12,30	1,25		2,45	1,20	0,960	0,300	946,4	1063	188	448	0,600	1587,0
18 0016			34,0	12,30	1,50		2,70	1,20	0,800	0,300	1447,0	1188	313	493	0,600	2527,0
18 0017			34,0	14,30	1,25		2,40	1,15	0,920	0,287	912,8	964	177	461	0,575	1546,0
18 0018			34,0	14,30	1,50		2,55	1,05	0,700	0,262	1224,0	953	297	447	0,525	2192,0
18 0019			34,0	16,30	1,50		2,55	1,05	0,700	0,262	1291,0	942	283	495	0,525	2313,0
18 0020			34,0	16,30	2,00		2,85	0,85	0,425	0,212	2097,0	877	445	449	0,425	4003,0
17 0081	C		35,5	18,30	0,90		2,05	1,15	1,277	0,287	457,7	737	2	427	0,575	712,4
18 0021	B		35,5	18,30	1,25		2,25	1,00	0,800	0,250	730,9	724	168	409	0,500	1277,0
18 0022	A		35,5	18,30	2,00		2,80	0,80	0,400	0,200	1864,0	749	393	409	0,400	3576,0
18 0023			40,0	14,30	1,25		2,65	1,40	1,120	0,350	904,4	961	98	406	0,700	1459,0
18 0024			40,0	14,30	1,50		2,80	1,30	0,866	0,325	1188,0	962	218	398	0,650	2040,0
18 0025			40,0	14,30	1,75		3,05	1,30	0,742	0,325	1722,0	1061	316	433	0,650	3051,0
18 0026			40,0	14,30	2,00		3,05	1,05	0,525	0,262	1800,0	878	393	349	0,525	3363,0
18 0027			40,0	16,30	1,50		2,80	1,30	0,866	0,325	1224,0	928	199	430	0,650	2102,0
18 0028			40,0	16,30	1,75		3,10	1,35	0,771	0,337	1881,0	1076	290	494	0,675	3309,0
18 0029			40,0	16,30	2,00		3,10	1,10	0,550	0,275	1972,0	897	375	402	0,550	3663,0
18 0030			40,0	18,30	2,00		3,15	1,15	0,575	0,287	2182,0	933	365	466	0,575	4030,0
17 0082	C		40,0	20,40	1,00		2,30	1,30	1,300	0,325	565,3	734	-4	422	0,650	875,8
18 0031	B		40,0	20,40	1,50		2,65	1,15	0,766	0,287	1109,0	774	196	431	0,575	1953,0
18 0032			40,0	20,40	2,00		3,10	1,10	0,550	0,275	2175,0	882	354	484	0,550	4041,0
18 0033	A		40,0	20,40	2,25		3,15	0,90	0,400	0,225	2336,0	746	392	403	0,450	4481,0
18 0034			40,0	20,40	2,50		3,45	0,95	0,380	0,237	3351,0	864	470	466	0,475	6453,0

\*\*)  $sc = h_0 = l_0 - t$  for disc springs without contact surfaces  
 $sc = h_0 = l_0 - t'$  for disc springs with contact surfaces

spring force F in N			stress $\sigma$ in N/mm <sup>2</sup>					$s_c^{**}$					Weight
$s = 0,5 h_0$			$s = 0,75 h_0$										1.000 pcs.
$\sigma_I$	$\sigma_{II}$	$\sigma_{III}$	s	F	$\sigma_I$	$\sigma_{II}$	$\sigma_{III}$	s	F	$\sigma_I$	$\sigma_{II}$	$\sigma_{III}$	in kg
1675	136	919	0,675	599,6	2320	396	1259	0,900	635,4	2837	785	1519	2,055
1371	440	730	0,525	862,3	1940	776	1023	0,700	1050	2432	1190	1268	2,642
1473	898	757	0,412	2926,0	2138	1419	1091	0,550	3821	2755	1988	1395	4,403
1624	239	692	0,712	661,5	2264	532	950	0,950	722,7	2787	940	1149	3,354
1994	459	837	0,750	1289,0	2798	880	1158	1,000	1486	3475	1429	1414	4,191
2300	765	949	0,750	2394,0	3258	1340	1326	1,000	2902	4089	2042	1637	5,238
1663	911	660	0,525	2723,0	2401	1461	943	0,700	3511	3076	2074	1193	6,286
1781	425	870	0,712	1268,0	2502	807	1208	0,950	1482	3111	1302	1480	3,914
1777	691	849	0,637	2083,0	2529	1172	1196	0,850	2590	3191	1743	1491	4,893
1729	883	812	0,562	3077,0	2488	1431	1157	0,750	3949	3176	2049	1462	5,872
1680	154	950	0,750	801,4	2330	422	1304	1,000	858,8	2852	817	1577	2,872
1406	429	776	0,600	1107,0	1986	765	1086	0,800	1342	2486	1183	1344	3,590
1770	667	968	0,637	2240,0	2516	1138	1365	0,850	2785	3171	1701	1703	4,486
1440	795	772	0,487	2841,0	2080	1274	1106	0,650	3680	2665	1806	1407	5,386
1430	94	825	0,787	686,8	1978	308	1130	1,050	721,6	2415	633	1363	3,583
1512	530	844	0,675	1913,0	2145	917	1187	0,900	2359	2696	1386	1478	5,599
1716	734	950	0,675	3230,0	2451	1223	1346	0,900	4077	3104	1795	1689	6,717
1408	814	766	0,525	3871,0	2038	1296	1102	0,700	5036	2619	1826	1405	7,839
1702	1020	924	0,562	6173,0	2467	1615	1331	0,750	8054	3176	2267	1701	8,956
1751	250	742	0,900	1110,0	2439	563	1018	1,200	1208	3002	1001	1231	6,194
2001	500	833	0,900	2024,0	2814	938	1154	1,200	2359	3502	1501	1412	7,743
2251	750	923	0,900	3363,0	3190	1313	1290	1,200	4076	4003	2001	1593	9,280
1816	466	858	0,862	1993,0	2555	868	1193	1,150	2347	3182	1382	1464	7,330
1813	687	841	0,787	2990,0	2579	1172	1183	1,050	3704	3250	1750	1472	8,799
1790	660	933	0,787	3155,0	2543	1131	1313	1,050	3908	3203	1696	1635	8,233
1692	952	860	0,637	5783,0	2446	1520	1234	0,850	7498	3138	2150	1570	10,978
1370	108	786	0,862	831,9	1897	320	1078	1,150	883,8	2319	637	1302	5,134
1369	416	766	0,750	1699,0	1935	743	1073	1,000	2059	2421	1149	1329	7,131
1448	837	785	0,600	5187,0	2095	1332	1128	0,800	6747	2692	1878	1439	11,410
1799	319	750	1,050	1780,0	2514	664	1033	1,400	1984	3105	1132	1253	10,755
1818	542	743	0,975	2668,0	2568	973	1034	1,300	3184	3212	1510	1271	12,905
2015	739	813	0,975	4119,0	2863	1268	1139	1,300	5056	3605	1904	1412	15,056
1688	855	664	0,787	4769,0	2427	1387	943	1,050	6096	3098	1988	1188	17,207
1752	503	802	0,975	2749,0	2472	911	1118	1,300	3281	3088	1422	1376	12,339
2040	692	926	1,012	4435,0	2891	1207	1297	1,350	5410	3631	1834	1606	14,396
1719	825	764	0,825	5169,0	2467	1349	1084	1,100	6580	3141	1948	1364	16,499
1785	810	883	0,862	5656,0	2556	1338	1252	1,150	7171	3246	1946	1573	15,599
1363	98	776	0,975	1017,0	1887	305	1063	1,300	1072	2305	617	1283	7,299
1465	474	810	0,862	2621,0	2073	835	1136	1,150	3201	2599	1278	1410	10,948
1689	783	920	0,825	5701,0	2421	1288	1307	1,100	7258	3077	1868	1646	14,590
1441	835	774	0,675	6500,0	2086	1328	1112	0,900	8456	2680	1871	1419	16,422
1673	997	896	0,712	9390,0	2424	1579	1290	0,950	12243	3120	2219	1649	18,246

Tab. III: Disc Springs according to DIN and Mubea standard

STANDARD DIMENSIONS ACCORDING TO DIN EN 16983 (FORMER DIN 2093) AND MUBEA STANDARDS

Part No.	DIN Series	not on Stock	Dimensions in mm							spring deflection s in mm					spring force F in N	
			D <sub>e</sub>	D <sub>i</sub>	t	t'	l <sub>0</sub>	h <sub>0</sub>	h <sub>0</sub> /t	s = 0,25 h <sub>0</sub>					s = 0,5 h <sub>0</sub>	
										s	F	σ <sub>I</sub>	σ <sub>II</sub>	σ <sub>III</sub>	s	F
18 0035	C		45,0	22,40	1,25		2,85	1,60	1,280	0,400	1041,0	883	4	497	0,800	1620,0
18 0036	B		45,0	22,40	1,75		3,05	1,30	0,742	0,325	1524,0	795	214	433	0,650	2701,0
18 0037	A		45,0	22,40	2,50		3,50	1,00	0,400	0,250	2773,0	726	383	384	0,500	5320,0
18 0038			48,0	16,30	1,50		3,00	1,50	1,000	0,375	1048,0	832	135	333	0,750	1740,0
18 0039			50,0	18,40	1,25		2,85	1,60	1,280	0,400	756,9	742	24	325	0,800	1178,0
18 0040			50,0	18,40	1,50		3,15	1,65	1,100	0,412	1166,0	855	93	370	0,825	1890,0
18 0041			50,0	18,40	2,00		3,65	1,65	0,825	0,412	2229,0	1013	251	428	0,825	3868,0
18 0042			50,0	18,40	2,50		4,15	1,65	0,660	0,412	3870,0	1171	409	486	0,825	7002,0
18 0043			50,0	18,40	3,00		4,20	1,20	0,400	0,300	4179,0	891	488	357	0,600	8018,0
18 0044			50,0	20,40	2,00		3,50	1,50	0,750	0,375	1966,0	865	244	397	0,750	3478,0
18 0045			50,0	20,40	2,50		3,85	1,35	0,540	0,337	3008,0	876	373	393	0,675	5601,0
18 0046			50,0	22,40	2,00		3,60	1,60	0,800	0,400	2247,0	932	228	466	0,800	3924,0
18 0047			50,0	22,40	2,50		3,90	1,40	0,560	0,350	3261,0	904	364	442	0,700	6044,0
18 0048	C		50,0	25,40	1,25		2,85	1,60	1,280	0,400	853,7	717	2	410	0,800	1328,0
18 0049			50,0	25,40	1,50		3,10	1,60	1,066	0,400	1242,0	789	74	447	0,800	2028,0
18 0050	B		50,0	25,40	2,00		3,40	1,40	0,700	0,350	1949,0	777	230	430	0,700	3491,0
18 0051			50,0	25,40	2,25		3,75	1,50	0,666	0,375	2905,0	921	292	508	0,750	5249,0
18 0052			50,0	25,40	2,50		3,90	1,40	0,560	0,350	3473,0	903	355	494	0,700	6437,0
18 0053	A		50,0	25,40	3,00		4,10	1,10	0,366	0,275	4255,0	762	424	409	0,550	8214,0
18 0054	C		56,0	28,50	1,50		3,45	1,95	1,300	0,487	1458,0	843	-4	483	0,975	2259,0
18 0055	B		56,0	28,50	2,00		3,60	1,60	0,800	0,400	1910,0	744	173	415	0,800	3335,0
18 0056			56,0	28,50	2,50		4,20	1,70	0,680	0,425	3638,0	931	287	515	0,850	6550,0
18 0057	A		56,0	28,50	3,00		4,30	1,30	0,433	0,325	4142,0	747	371	404	0,650	7895,0
18 0058			60,0	20,50	2,00		4,20	2,20	1,100	0,550	2528,0	1082	125	440	1,100	4097,0
18 0059			60,0	20,50	2,50		4,70	2,20	0,880	0,550	4151,0	1233	276	491	1,100	7102,0
18 0060			60,0	20,50	3,00		5,20	2,20	0,733	0,550	6434,0	1384	426	543	1,100	11429,0
18 0061			60,0	25,50	2,50		4,40	1,90	0,760	0,475	3447,0	949	259	451	0,950	6081,0
18 0062			60,0	25,50	3,00		4,65	1,65	0,550	0,412	4495,0	889	369	414	0,825	8352,0
18 0063			60,0	30,50	2,50		4,50	2,00	0,800	0,500	4059,0	1012	236	564	1,000	7088,0
18 0064			60,0	30,50	2,75		4,75	2,00	0,727	0,500	5125,0	1075	299	596	1,000	9117,0
18 0065			60,0	30,50	3,00		4,70	1,70	0,566	0,425	5083,0	917	356	502	0,850	9407,0
18 0066			60,0	30,50	3,50		5,00	1,50	0,428	0,375	6591,0	874	437	472	0,750	12574,0
18 0067	C		63,0	31,00	1,80		4,15	2,35	1,305	0,587	2364,0	961	-4	536	1,175	3658,0
18 0068	B		63,0	31,00	2,50		4,25	1,75	0,700	0,437	2942,0	763	227	410	0,875	5270,0
18 0069			63,0	31,00	3,00		4,70	1,70	0,566	0,425	4524,0	830	324	441	0,850	8373,0
18 0070	A		63,0	31,00	3,50		4,90	1,40	0,400	0,350	5399,0	726	383	380	0,700	10359,0
18 0071			70,0	24,50	3,00		5,30	2,30	0,766	0,575	5080,0	1070	306	430	1,150	8948,0
18 0072			70,0	24,50	3,50		6,00	2,50	0,714	0,625	8446,0	1324	421	529	1,250	15076,0
18 0073			70,0	25,50	2,00		4,50	2,50	1,250	0,625	2408,0	938	43	406	1,250	3771,0
18 0074			70,0	30,50	2,50		4,90	2,40	0,960	0,600	3755,0	961	153	475	1,200	6297,0
18 0075			70,0	30,50	3,00		5,10	2,10	0,700	0,525	4676,0	895	276	433	1,050	8376,0
18 0076			70,0	35,50	3,00		5,10	2,10	0,700	0,525	5028,0	891	264	493	1,050	9007,0

\*\*)  $sc = h_0 = l_0 - t$  for disc springs without contact surfaces  
 $sc = h_0 = l_0 - t'$  for disc springs with contact surfaces

spring force F in N			stress $\sigma$ in N/mm <sup>2</sup>					$s_c^{**}$					Weight
$s = 0,5 h_0$			$s = 0,75 h_0$										1.000 pcs.
$\sigma_I$	$\sigma_{II}$	$\sigma_{III}$	s	F	$\sigma_I$	$\sigma_{II}$	$\sigma_{III}$	s	F	$\sigma_I$	$\sigma_{II}$	$\sigma_{III}$	in kg
1641	134	914	1,200	1891,0	2273	389	1253	1,600	2007	2779	770	1514	11,739
1507	512	814	0,975	3646,0	2135	892	1144	1,300	4475	2681	1355	1421	16,434
1403	815	737	0,750	7716,0	2031	1296	1059	1,000	10037	2610	1825	1350	23,478
1564	370	618	1,125	2195,0	2197	704	855	1,500	2531	2730	1138	1043	18,850
1381	151	597	1,200	1375,0	1918	380	817	1,600	1459	2352	712	984	16,657
1602	294	684	1,237	2319,0	2239	605	942	1,650	2600	2768	1024	1144	19,988
1918	610	800	1,237	5114,0	2713	1079	1116	1,650	6163	3400	1656	1377	26,651
2234	926	916	1,237	9643,0	3187	1552	1291	1,650	12038	4032	2288	1609	33,314
1725	1033	685	0,900	11630,0	2500	1636	983	1,200	15128	3219	2296	1251	39,977
1642	578	745	1,125	4687,0	2330	1000	1045	1,500	5745	2929	1510	1295	25,695
1680	817	746	1,012	7919,0	2412	1334	1060	1,350	10098	3072	1922	1335	32,118
1763	556	872	1,200	5222,0	2493	985	1220	1,600	6329	3123	1514	1509	24,639
1730	806	838	1,050	8510,0	2480	1324	1190	1,400	10817	3152	1920	1496	30,799
1332	106	755	1,200	1550,0	1845	312	1035	1,600	1646	2256	621	1251	14,294
1476	250	828	1,200	2512,0	2061	528	1145	1,600	2844	2543	909	1397	17,153
1476	537	810	1,050	4762,0	2097	923	1140	1,400	5898	2639	1388	1421	22,871
1752	675	959	1,125	7217,0	2494	1147	1353	1,500	8997	3145	1709	1690	25,730
1728	789	938	1,050	9063,0	2474	1301	1332	1,400	11519	3143	1891	1677	28,589
1476	897	787	0,825	11976,0	2142	1418	1135	1,100	15640	2759	1987	1451	34,306
1565	112	889	1,462	2622,0	2165	350	1218	1,950	2766	2645	709	1470	21,489
1406	428	778	1,200	4438,0	1987	765	1090	1,600	5379	2486	1183	1349	28,653
1770	666	972	1,275	8978,0	2517	1138	1369	1,700	11164	3173	1701	1709	35,816
1441	795	775	0,975	11388,0	2080	1274	1110	1,300	14752	2666	1806	1412	42,979
2028	386	812	1,650	5026,0	2837	784	1119	2,200	5636	3509	1320	1358	39,208
2330	688	916	1,650	9255,0	3289	1237	1273	2,200	11008	4112	1923	1564	49,009
2631	990	1019	1,650	15465,0	3742	1690	1428	2,200	19022	4716	2527	1771	58,811
1799	616	847	1,425	8175,0	2551	1072	1187	1,900	9997	3204	1627	1471	45,465
1704	812	787	1,237	11784,0	2445	1330	1117	1,650	15002	3111	1922	1405	54,557
1914	583	1058	1,500	9432,0	2704	1041	1481	2,000	11433	3384	1610	1834	41,149
2039	708	1122	1,500	12356,0	2892	1228	1576	2,000	15217	3634	1860	1961	45,264
1754	793	953	1,275	13226,0	2511	1309	1353	1,700	16792	3188	1906	1703	57,608
1685	937	905	1,125	18153,0	2434	1499	1297	1,500	23528	3121	2123	1650	57,608
1785	130	986	1,762	4238,0	2470	402	1351	2,350	4463	3018	811	1629	33,381
1449	531	773	1,312	7189,0	2059	912	1088	1,750	8904	2592	1368	1355	46,362
1587	721	838	1,275	11772,0	2273	1190	1189	1,700	14946	2886	1731	1495	56,635
1403	815	729	1,050	15025,0	2030	1296	1047	1,400	19545	2609	1826	1335	64,907
2031	721	806	1,725	12007,0	2883	1245	1128	2,300	14663	3626	1878	1396	79,526
2519	971	994	1,875	20495,0	3585	1650	1395	2,500	25309	4522	2458	1733	92,781
1748	214	748	1,875	4437,0	2431	512	1024	2,500	4755	2985	939	1235	52,401
1807	422	883	1,800	8031,0	2538	806	1225	2,400	9360	3153	1306	1501	61,186
1701	640	814	1,575	11426,0	2418	1093	1145	2,100	14152	3048	1634	1426	73,423
1694	617	928	1,575	12287,0	2407	1060	1307	2,100	15218	3029	1593	1628	67,319

Tab. III: Disc Springs according to DIN and Mubea standard

STANDARD DIMENSIONS ACCORDING TO DIN EN 16983 (FORMER DIN 2093) AND MUBEA STANDARDS

Part No.	DIN Series	not on Stock	Dimensions in mm							spring deflection s in mm					spring force F in N	
			D <sub>e</sub>	D <sub>i</sub>	t	t'	l <sub>0</sub>	h <sub>0</sub>	h <sub>0</sub> /t	s = 0,25 h <sub>0</sub>					s = 0,5 h <sub>0</sub>	
										s	F	σ <sub>I</sub>	σ <sub>II</sub>	σ <sub>III</sub>	s	F
18 0077			70,0	35,50	3,50		5,30	1,80	0,514	0,450	6077,0	809	347	440	0,900	11384,0
18 0078			70,0	35,50	4,00		5,80	1,80	0,450	0,450	8757,0	891	430	482	0,900	16634,0
18 0079			70,0	35,50	4,00	3,75	5,80	1,80	0,450	0,450	9167,0	977	357	535	0,900	17018,0
18 0080			70,0	40,50	4,00		5,70	1,70	0,425	0,425	9025,0	858	424	521	0,850	17230,0
18 0081			70,0	40,50	4,00	3,75	5,70	1,70	0,425	0,425	9423,0	942	354	579	0,850	17604,0
18 0082			70,0	40,50	5,00		6,40	1,40	0,280	0,350	13646,0	807	513	484	0,700	26719,0
18 0083			70,0	40,50	5,00	4,7	6,40	1,40	0,280	0,350	14004,0	886	457	537	0,700	27059,0
18 0084	C		71,0	36,00	2,00		4,60	2,60	1,300	0,650	2861,0	932	-5	532	1,300	4432,0
18 0085	B		71,0	36,00	2,50		4,50	2,00	0,800	0,500	2894,0	723	169	402	1,000	5054,0
18 0086	A		71,0	36,00	4,00		5,60	1,60	0,400	0,400	7379,0	748	393	402	0,800	14157,0
18 0087			71,0	36,00	4,00	3,75	5,60	1,60	0,400	0,400	7685,0	821	334	447	0,800	14445,0
18 0088			80,0	30,50	2,50		5,30	2,80	1,120	0,700	3664,0	943	91	421	1,400	5911,0
18 0089			80,0	31,00	3,00		5,50	2,50	0,833	0,625	4531,0	890	212	393	1,250	7847,0
18 0090			80,0	31,00	4,00		6,10	2,10	0,525	0,525	7319,0	856	378	366	1,050	13677,0
18 0091			80,0	31,00	4,00	3,75	6,10	2,10	0,525	0,525	7717,0	933	308	406	1,050	14049,0
18 0092			80,0	35,50	4,00		6,20	2,20	0,550	0,550	8118,0	884	364	428	1,100	15083,0
18 0093			80,0	35,50	4,00	3,75	6,20	2,20	0,550	0,550	8577,0	964	289	474	1,100	15512,0
18 0094			80,0	36,00	3,00		5,70	2,70	0,900	0,675	5401,0	964	181	487	1,350	9196,0
18 0095	C		80,0	41,00	2,25		5,20	2,95	1,311	0,737	3698,0	942	-9	544	1,475	5715,0
18 0096	B		80,0	41,00	3,00		5,30	2,30	0,766	0,575	4450,0	774	196	434	1,150	7838,0
18 0097			80,0	41,00	4,00		6,20	2,20	0,550	0,550	8726,0	883	354	486	1,100	16213,0
18 0098			80,0	41,00	4,00	3,75	6,20	2,20	0,550	0,550	9220,0	965	278	538	1,100	16674,0
18 0099	A		80,0	41,00	5,00		6,70	1,70	0,340	0,425	11821,0	755	439	407	0,850	22928,0
18 0100			80,0	41,00	5,00	4,7	6,70	1,70	0,340	0,425	12211,0	827	385	452	0,850	23296,0
18 0101	C		90,0	46,00	2,50		5,70	3,20	1,280	0,800	4232,0	886	2	509	1,600	6585,0
18 0102	B		90,0	46,00	3,50		6,00	2,50	0,714	0,625	5836,0	756	216	421	1,250	10416,0
18 0103	A		90,0	46,00	5,00		7,00	2,00	0,400	0,500	11267,0	728	382	394	1,000	21617,0
18 0104			90,0	46,00	5,00	4,7	7,00	2,00	0,400	0,500	11713,0	796	327	437	1,000	22035,0
18 0105			100,0	41,00	4,00		7,20	3,20	0,800	0,800	8715,0	944	238	437	1,600	15219,0
18 0106			100,0	41,00	4,00	3,8	7,20	3,20	0,800	0,800	9215,0	1004	173	470	1,600	15683,0
18 0107			100,0	41,00	5,00		7,75	2,75	0,550	0,687	12345,0	896	374	404	1,375	22937,0
18 0108			100,0	41,00	5,00	4,7	7,75	2,75	0,550	0,687	13013,0	973	303	446	1,375	23561,0
18 0109	C		100,0	51,00	2,70		6,20	3,50	1,296	0,875	4779,0	853	-3	490	1,750	7410,0
18 0110	B		100,0	51,00	3,50		6,30	2,80	0,800	0,700	5624,0	715	167	399	1,400	9823,0
18 0111			100,0	51,00	4,00		7,00	3,00	0,750	0,750	8673,0	854	225	476	1,500	15341,0
18 0112			100,0	51,00	4,00	3,8	7,00	3,00	0,750	0,750	9156,0	912	165	513	1,500	15789,0
18 0113			100,0	51,00	5,00		7,80	2,80	0,560	0,700	13924,0	903	355	496	1,400	25810,0
18 0114			100,0	51,00	5,00	4,7	7,80	2,80	0,560	0,700	14689,0	983	281	546	1,400	26525,0
18 0115	A		100,0	51,00	6,00		8,20	2,20	0,366	0,550	17061,0	763	424	411	1,100	32937,0
18 0116			100,0	51,00	6,00	5,6	8,20	2,20	0,366	0,550	17753,0	843	361	461	1,100	33589,0
19 0001			100,0	51,00	7,00	6,55	9,20	2,20	0,314	0,550	27374,0	950	457	516	1,100	52454,0
18 0117	C		112,0	57,00	3,00		6,90	3,90	1,300	0,975	5834,0	843	-4	483	1,950	9038,0

\*\*)  $sc = h_0 = l_0 - t$  for disc springs without contact surfaces  
 $sc = h_0 = l_0 - t'$  for disc springs with contact surfaces

spring force F in N			stress $\sigma$ in N/mm <sup>2</sup>					$s_c^{**}$					Weight
$s = 0,5 h_0$			$s = 0,75 h_0$										1.000 pcs.
$\sigma_I$	$\sigma_{II}$	$\sigma_{III}$	s	F	$\sigma_I$	$\sigma_{II}$	$\sigma_{III}$	s	F	$\sigma_I$	$\sigma_{II}$	$\sigma_{III}$	in kg
1551	760	837	1,350	16177,0	2228	1239	1193	1,800	20714	2839	1784	1507	78,539
1716	925	921	1,350	23923,0	2476	1486	1319	1,800	30919	3169	2114	1675	89,759
1877	790	1022	1,350	23923,0	2701	1299	1460	2,050	33656	3831	2244	2045	84,149
1654	910	1000	1,275	24889,0	2388	1459	1435	1,700	32274	3059	2069	1827	80,388
1813	779	1108	1,275	24889,0	2611	1277	1588	1,950	35467	3731	2215	2246	75,364
1572	1068	938	1,050	39410,0	2295	1665	1364	1,400	51911	2975	2303	1760	100,485
1722	963	1040	1,050	39410,0	2509	1518	1509	1,700	61324	3841	2680	2289	94,456
1730	125	980	1,950	5144,0	2394	388	1342	2,600	5426	2924	784	1620	46,177
1366	417	754	1,500	6725,0	1931	744	1055	2,000	8152	2416	1150	1306	57,722
1445	837	772	1,200	20535,0	2091	1332	1109	1,600	26712	2687	1877	1415	92,355
1583	727	857	1,200	20535,0	2286	1179	1230	1,850	29661	3302	2039	1755	86,582
1765	303	778	2,100	7211,0	2464	637	1070	2,800	8039	3042	1093	1299	84,305
1682	520	735	1,875	10352,0	2378	926	1025	2,500	12451	2978	1428	1265	100,598
1644	823	695	1,575	19394,0	2363	1338	989	2,100	24791	3014	1920	1246	134,130
1788	694	771	1,575	19394,0	2564	1159	1094	2,350	26327	3566	1989	1495	125,747
1693	802	812	1,650	21280,0	2428	1314	1154	2,200	27093	3089	1901	1452	126,750
1843	664	899	1,650	21280,0	2637	1124	1274	2,450	28564	3638	1945	1731	118,828
1817	474	909	2,025	11919,0	2557	879	1265	2,700	14106	3186	1396	1556	94,401
1749	117	1000	2,212	6613,0	2419	379	1370	2,950	6950	2953	778	1652	65,460
1466	474	814	1,725	10518,0	2074	835	1142	2,300	12844	2600	1278	1417	87,281
1690	783	924	1,650	22874,0	2422	1288	1314	2,200	29122	3078	1868	1655	116,374
1843	642	1021	1,650	22874,0	2634	1094	1448	2,450	30703	3630	1906	1970	109,100
1465	924	786	1,275	33559,0	2130	1453	1135	1,700	43952	2750	2028	1456	145,468
1602	822	871	1,275	33559,0	2324	1312	1255	2,000	50035	3434	2269	1834	136,740
1646	130	938	2,400	7684,0	2280	385	1286	3,200	8157	2787	766	1553	92,231
1434	509	792	1,875	14161,0	2035	879	1114	2,500	17487	2560	1326	1387	129,124
1406	814	757	1,500	31354,0	2035	1295	1088	2,000	40786	2615	1826	1387	184,463
1535	712	837	1,500	31354,0	2217	1153	1201	2,300	45141	3188	1979	1707	173,395
1788	577	818	2,400	20251,0	2530	1017	1144	3,200	24547	3172	1557	1414	205,153
1898	457	880	2,400	20251,0	2681	851	1228	3,400	24574	3503	1501	1577	194,896
1717	823	767	2,062	32361,0	2464	1346	1089	2,750	41201	3136	1944	1370	256,441
1862	691	846	2,062	32361,0	2665	1164	1198	3,050	43381	3669	1933	1622	241,055
1584	116	902	2,625	8609,0	2192	357	1235	3,500	9091	2678	721	1491	123,164
1351	411	749	2,100	13070,0	1909	734	1049	2,800	15843	2389	1136	1298	159,657
1618	540	894	2,250	20674,0	2292	944	1255	3,000	25338	2877	1439	1559	182,465
1724	429	962	2,250	20674,0	2437	792	1348	3,200	25555	3198	1394	1747	173,342
1728	789	942	2,100	36339,0	2475	1301	1337	2,800	46189	3144	1891	1683	228,081
1877	651	1036	2,100	36339,0	2682	1111	1468	3,100	48503	3676	1923	1987	214,397
1477	897	790	1,650	48022,0	2143	1418	1139	2,200	62711	2760	1987	1457	273,698
1629	778	885	1,650	48022,0	2358	1253	1273	2,600	71153	3483	2207	1858	255,451
1843	972	996	1,650	75840,0	2679	1543	1439	2,650	115982	4053	2729	2152	298,787
1565	112	889	2,925	10489,0	2165	350	1218	3,900	11064	2645	709	1470	171,917

Tab. III: Disc Springs according to DIN and Mubea standard

STANDARD DIMENSIONS ACCORDING TO DIN EN 16983 (FORMER DIN 2093) AND MUBEA STANDARDS

Part No.	DIN Series	not on Stock	Dimensions in mm							spring deflection s in mm					spring force F in N	
			D <sub>e</sub>	D <sub>i</sub>	t	t'	l <sub>0</sub>	h <sub>0</sub>	h <sub>0</sub> /t	s = 0,25 h <sub>0</sub>					s = 0,5 h <sub>0</sub>	
										s	F	σ <sub>I</sub>	σ <sub>II</sub>	σ <sub>III</sub>	s	F
18 0118	B		112,0	57,00	4,00		7,20	3,20	0,800	0,800	7639,0	744	173	415	1,600	13341,0
18 0119			112,0	57,00	4,00	3,75	7,20	3,20	0,800	0,800	8192,0	805	107	454	1,600	13855,0
18 0120	A		112,0	57,00	6,00		8,50	2,50	0,416	0,625	15800,0	712	363	384	1,250	30215,0
18 0121			112,0	57,00	6,00	5,6	8,50	2,50	0,416	0,625	16536,0	786	302	431	1,250	30906,0
18 0122			125,0	51,00	4,00		8,50	4,50	1,125	1,125	10096,0	980	86	463	2,250	16265,0
18 0123			125,0	51,00	4,00	3,8	8,50	4,50	1,125	1,125	10705,0	1031	19	492	2,250	16830,0
18 0124			125,0	51,00	5,00		8,90	3,90	0,780	0,975	13063,0	913	241	420	1,950	22931,0
18 0125			125,0	51,00	5,00	4,75	8,90	3,90	0,780	0,975	13804,0	972	179	452	1,950	23619,0
18 0126			125,0	51,00	6,00		9,40	3,40	0,566	0,850	17027,0	859	349	386	1,700	31514,0
18 0127			125,0	51,00	6,00	5,65	9,40	3,40	0,566	0,850	17944,0	931	282	426	1,700	32369,0
18 0128			125,0	61,00	5,00		9,00	4,00	0,800	1,000	14615,0	930	220	500	2,000	25526,0
18 0129			125,0	61,00	5,00	4,75	9,00	4,00	0,800	1,000	15455,0	990	155	538	2,000	26305,0
18 0130			125,0	61,00	6,00		9,60	3,60	0,600	0,900	19789,0	908	334	481	1,800	36336,0
18 0131			125,0	61,00	6,00	5,6	9,60	3,60	0,600	0,900	21079,0	996	249	535	1,800	37539,0
19 0002			125,0	61,00	8,00	7,5	10,90	2,90	0,362	0,725	34434,0	937	415	492	1,450	65305,0
18 0132	C		125,0	64,00	3,50		8,00	4,50	1,285	1,125	8514,0	907	0	522	2,250	13231,0
18 0133	B		125,0	64,00	5,00		8,50	3,50	0,700	0,875	12238,0	778	229	433	1,750	21924,0
18 0134			125,0	64,00	5,00	4,7	8,50	3,50	0,700	0,875	13031,0	842	163	475	1,750	22661,0
18 0135			125,0	64,00	6,00		9,60	3,60	0,600	0,900	20348,0	912	331	504	1,800	37362,0
18 0136			125,0	64,00	6,00	5,6	9,60	3,60	0,600	0,900	21674,0	1000	246	560	1,800	38599,0
19 0003			125,0	64,00	7,00	6,55	10,00	3,00	0,428	0,750	25528,0	886	335	489	1,500	47615,0
19 0004	A		125,0	64,00	8,00	7,5	10,60	2,60	0,325	0,650	31118,0	825	391	450	1,300	59520,0
18 0137			125,0	71,00	6,00		9,30	3,30	0,550	0,825	19538,0	835	328	504	1,650	36302,0
18 0138			125,0	71,00	6,00	5,6	9,30	3,30	0,550	0,825	20725,0	919	250	561	1,650	37411,0
19 0005			125,0	71,00	8,00	7,45	10,90	2,90	0,362	0,725	38416,0	974	408	587	1,450	72705,0
19 0006			125,0	71,00	10,00	9,3	11,80	1,80	0,180	0,450	42821,0	674	409	398	0,900	84082,0
18 0139	C		140,0	72,00	3,80		8,70	4,90	1,289	1,225	9514,0	856	-2	495	2,450	14773,0
18 0140	B		140,0	72,00	5,00		9,00	4,00	0,800	1,000	12014,0	745	173	419	2,000	20982,0
18 0141			140,0	72,00	5,00	4,7	9,00	4,00	0,800	1,000	12847,0	803	109	457	2,000	21756,0
19 0007	A		140,0	72,00	8,00	7,5	11,20	3,20	0,400	0,800	31903,0	846	343	467	1,600	59967,0
18 0142			150,0	61,00	5,00		10,30	5,30	1,060	1,325	15292,0	976	114	458	2,650	25021,0
18 0143			150,0	61,00	5,00	4,75	10,30	5,30	1,060	1,325	16221,0	1029	48	488	2,650	25883,0
18 0144			150,0	61,00	6,00		10,80	4,80	0,800	1,200	19560,0	946	239	435	2,400	34161,0
18 0145			150,0	61,00	6,00	5,7	10,80	4,80	0,800	1,200	20684,0	1006	174	463	2,400	35204,0
19 0008			150,0	61,00	7,00	6,55	11,80	4,80	0,685	1,200	30593,0	1135	245	525	2,400	53294,0
18 0146			150,0	71,00	6,00		10,85	4,85	0,808	1,212	21067,0	943	221	494	2,425	36714,0
18 0147			150,0	71,00	6,00	5,6	10,85	4,85	0,808	1,212	22703,0	1023	131	544	2,425	38235,0
19 0009			150,0	71,00	8,00	7,5	12,05	4,05	0,506	1,012	35885,0	983	321	510	2,025	65655,0
19 0010			150,0	81,00	8,00	7,5	12,00	4,00	0,500	1,000	38230,0	982	315	572	2,000	70060,0
19 0011			150,0	81,00	10,00	9,4	13,40	3,40	0,340	0,850	57601,0	950	438	544	1,700	109889,0
18 0148	C		160,0	82,00	4,30		9,90	5,60	1,302	1,400	12162,0	852	-6	491	2,800	18832,0
18 0149			160,0	82,00	4,30	4,15	9,90	5,60	1,302	1,400	12653,0	880	-45	510	2,800	19288,0

\*\*)  $sc = h_0 = l_0 - t$  for disc springs without contact surfaces  
 $sc = h_0 = l_0 - t'$  for disc springs with contact surfaces



spring force F in N			stress $\sigma$ in N/mm <sup>2</sup>					$s_c^{**}$					Weight
$s = 0,5 h_0$			$s = 0,75 h_0$										1.000 pcs.
$\sigma_I$	$\sigma_{II}$	$\sigma_{III}$	s	F	$\sigma_I$	$\sigma_{II}$	$\sigma_{III}$	s	F	$\sigma_I$	$\sigma_{II}$	$\sigma_{III}$	in kg
1406	428	778	2,400	17752,0	1987	765	1090	3,200	21518	2486	1183	1349	229,222
1518	305	850	2,400	17752,0	2139	595	1188	3,450	21468	2816	1114	1542	214,896
1373	777	737	1,875	43707,0	1985	1239	1058	2,500	56737	2548	1752	1348	343,833
1513	662	824	1,875	43707,0	2182	1081	1181	2,900	62863	3152	1894	1685	320,911
1832	299	856	3,375	19817,0	2556	640	1178	4,500	22060	3153	1109	1431	321,182
1924	176	908	3,375	19817,0	2680	471	1249	4,700	21268	3394	994	1554	305,123
1730	579	787	2,925	30669,0	2451	1012	1102	3,900	37342	3076	1541	1363	401,478
1838	463	847	2,925	30669,0	2599	852	1183	4,150	37492	3405	1492	1524	381,404
1645	770	733	2,550	44307,0	2358	1264	1039	3,400	56254	2999	1832	1306	481,773
1779	647	806	2,550	44307,0	2544	1095	1140	3,750	58923	3482	1868	1535	453,700
1758	542	938	3,000	33965,0	2485	965	1312	4,000	41170	3111	1489	1624	366,953
1869	421	1007	3,000	33965,0	2637	799	1407	4,250	41217	3439	1428	1811	348,605
1734	749	911	2,700	50722,0	2479	1247	1290	3,600	64028	3141	1827	1619	440,343
1897	592	1011	2,700	50722,0	2703	1031	1429	4,000	66696	3701	1831	1929	410,987
1812	893	945	2,175	93577,0	2625	1432	1359	3,400	138144	3856	2486	1972	550,429
1684	129	961	3,375	15416,0	2331	388	1318	4,500	16335	2849	777	1591	248,775
1477	537	816	2,625	29908,0	2099	923	1149	3,500	37041	2641	1387	1432	355,393
1596	415	893	2,625	29908,0	2262	754	1254	3,800	37673	3017	1350	1651	334,069
1741	746	955	2,700	52155,0	2487	1243	1352	3,600	65836	3150	1823	1697	426,471
1905	587	1059	2,700	52155,0	2714	1024	1497	4,000	68579	3713	1825	2022	398,040
1706	738	935	2,250	67216,0	2458	1208	1338	3,450	95795	3521	2099	1893	465,564
1599	833	867	1,950	85926,0	2322	1326	1252	3,100	129972	3477	2322	1854	533,039
1598	728	959	2,475	51217,0	2288	1201	1363	3,300	65207	2905	1746	1718	391,515
1754	583	1065	2,475	51217,0	2504	1001	1511	3,700	68887	3464	1776	2067	365,414
1882	883	1128	2,175	103964,0	2723	1424	1623	3,450	154927	4042	2537	2384	486,131
1322	845	779	1,350	124124,0	1943	1306	1141	2,500	223282	3413	2605	1986	606,848
1590	119	911	3,675	17195,0	2201	362	1249	4,900	18199	2690	728	1508	337,734
1408	428	787	3,000	27920,0	1990	764	1101	4,000	33843	2490	1182	1363	444,388
1518	310	856	3,000	27920,0	2136	601	1196	4,300	33792	2807	1117	1551	417,724
1631	747	895	2,400	85251,0	2355	1213	1284	3,700	123137	3402	2098	1832	666,581
1829	352	848	3,975	31041,0	2559	712	1171	5,300	35207	3165	1196	1426	578,881
1925	228	903	3,975	31041,0	2688	542	1245	5,550	34160	3422	1088	1557	549,937
1791	579	814	3,600	45456,0	2535	1020	1138	4,800	55098	3178	1562	1406	694,658
1901	459	875	3,600	45456,0	2686	855	1221	5,100	55161	3510	1506	1569	659,925
2156	604	986	3,600	70442,0	3062	1079	1385	5,250	89248	4119	1919	1830	758,335
1782	545	926	3,637	48749,0	2518	973	1295	4,850	58978	3152	1503	1602	645,829
1930	379	1017	3,637	48749,0	2721	743	1420	5,250	58662	3591	1408	1846	602,774
1884	725	969	3,037	91060,0	2702	1212	1378	4,550	124679	3769	2094	1895	807,287
1881	713	1088	3,000	97319,0	2697	1195	1549	4,500	133637	3764	2074	2136	737,000
1839	938	1049	2,550	158300,0	2668	1498	1512	4,000	236018	3941	2593	2211	923,710
1581	111	904	4,200	21843,0	2188	350	1238	5,600	23022	2672	712	1494	500,409
1632	38	938	4,200	21843,0	2256	250	1284	5,750	22250	2797	634	1572	482,953

Tab. III: Disc Springs according to DIN and Mubea standard

STANDARD DIMENSIONS ACCORDING TO DIN EN 16983 (FORMER DIN 2093) AND MUBEA STANDARDS

Part No.	DIN Series	not on Stock	Dimensions in mm							spring deflection s in mm					spring force F in N	
			D <sub>e</sub>	D <sub>i</sub>	t	t'	l <sub>0</sub>	h <sub>0</sub>	h <sub>0</sub> /t	s = 0,25 h <sub>0</sub>					s = 0,5 h <sub>0</sub>	
										s	F	σ <sub>I</sub>	σ <sub>II</sub>	σ <sub>III</sub>	s	F
18 0150	B		160,0	82,00	6,00		10,50	4,50	0,750	1,125	17203,0	751	197	420	2,250	30431,0
18 0151			160,0	82,00	6,00	5,6	10,50	4,50	0,750	1,125	18496,0	818	125	464	2,250	31633,0
19 0012	A		160,0	82,00	10,00	9,4	13,50	3,50	0,350	0,875	50547,0	857	390	469	1,750	96216,0
19 0013			160,0	82,00	11,00	10,2	14,50	3,50	0,318	0,875	66678,0	943	434	515	1,750	127338,0
18 0152	C		180,0	92,00	4,80		11,00	6,20	1,291	1,550	14646,0	828	-2	476	3,100	22731,0
18 0153			180,0	92,00	4,80	4,6	11,00	6,20	1,291	1,550	15352,0	861	-48	498	3,100	23387,0
18 0154	B		180,0	92,00	6,00		11,10	5,10	0,850	1,275	16558,0	705	144	396	2,550	28552,0
18 0155			180,0	92,00	6,00	5,6	11,10	5,10	0,850	1,275	17866,0	765	76	435	2,550	29767,0
19 0014	A		180,0	92,00	10,00	9,4	14,00	4,00	0,400	1,000	46850,0	796	327	437	2,000	88141,0
19 0015			180,0	92,00	13,00	12,1	16,50	3,50	0,269	0,875	84574,0	849	438	460	1,750	163392,0
18 0173			200,0	82,00	5,00	4,8	10,50	5,50	1,100	1,375	9700,0	600	26	290	2,750	15400,0
18 0174			200,0	82,00	6,00	5,8	13,00	7,00	1,177	1,750	22300,0	940	22	450	3,500	35000,0
19 0016			200,0	82,00	8,00	7,5	14,20	6,20	0,775	1,550	35519,0	977	162	458	3,100	60470,0
19 0041		*	200,0	82,00	8,50	8,1	14,50	6,00	0,706	1,500	38500,0	960	220	440	3,000	67200,0
19 0017			200,0	82,00	10,00	9,4	15,50	5,50	0,550	1,375	52053,0	973	303	446	2,750	94245,0
19 0018			200,0	82,00	12,00	11,25	16,60	4,60	0,383	1,150	67868,0	898	393	404	2,300	128082,0
19 0042			200,0	82,00	13,00	12,1	16,50	3,50	0,269	0,875	62100,0	700	370	310	1,750	120000,0
19 0019			200,0	92,00	10,00	9,4	15,60	5,60	0,560	1,400	55657,0	980	289	498	2,800	100501,0
19 0020			200,0	92,00	12,00	11,25	16,80	4,80	0,400	1,200	74572,0	930	385	465	2,400	140170,0
19 0021			200,0	92,00	14,00	13,05	18,10	4,10	0,292	1,025	95817,0	877	441	433	2,050	184267,0
18 0156	C		200,0	102,00	5,50		12,50	7,00	1,272	1,750	19817,0	861	5	494	3,500	30882,0
18 0157			200,0	102,00	5,50	5,3	12,50	7,00	1,272	1,750	20659,0	892	-37	514	3,500	31663,0
19 0022	B		200,0	102,00	8,00	7,5	13,60	5,60	0,700	1,400	33367,0	845	160	475	2,800	57955,0
19 0043		*	200,0	102,00	8,30	7,8	14,30	6,00	0,723	1,500	40500,0	950	170	530	3,000	70000,0
19 0044		*	200,0	102,00	9,00	8,6	14,60	5,60	0,622	1,400	44100,0	890	240	500	2,800	78800,0
19 0023			200,0	102,00	10,00	9,4	15,60	5,60	0,560	1,400	58756,0	983	281	546	2,800	106099,0
19 0045		*	200,0	102,00	11,00	10,3	15,00	4,00	0,364	1,000	49500,0	700	300	380	2,000	93900,0
19 0024	A		200,0	102,00	12,00	11,25	16,20	4,20	0,350	1,050	66983,0	792	357	432	2,100	127401,0
19 0025			200,0	102,00	14,00	13,05	18,20	4,20	0,300	1,050	103986,0	904	441	491	2,100	199671,0
18 0175		*	200,0	112,00	6,00	5,8	12,00	6,00	1,000	1,500	19700,0	770	50	470	3,000	32200,0
19 0026			200,0	112,00	12,00	11,25	16,20	4,20	0,350	1,050	71671,0	809	359	480	2,100	136317,0
19 0027			200,0	112,00	14,00	13,05	17,50	3,50	0,250	0,875	90576,0	745	397	438	1,750	175719,0
19 0046		*	200,0	112,00	15,00	14	18,00	3,00	0,200	0,750	93500,0	660	390	390	1,500	183100,0
19 0028			200,0	112,00	16,00	14,8	19,80	3,80	0,237	0,950	146464,0	927	493	545	1,900	284370,0
19 0029	C		225,0	112,00	6,50	6,2	13,60	7,10	1,092	1,775	23582,0	794	15	446	3,550	37417,0
19 0030	B		225,0	112,00	8,00	7,5	14,50	6,50	0,812	1,625	32870,0	812	104	450	3,250	55412,0
19 0047		*	225,0	112,00	9,00	8,45	15,50	6,50	0,722	1,625	43600,0	880	160	480	3,250	75300,0
19 0048		*	225,0	112,00	10,00	9,4	16,20	6,20	0,620	1,550	52800,0	880	220	480	3,100	93900,0
19 0049		*	225,0	112,00	10,80	10	16,50	5,70	0,528	1,425	58100,0	850	240	470	2,850	105200,0
19 0031	A		225,0	112,00	12,00	11,25	17,00	5,00	0,416	1,250	64497,0	772	304	415	2,500	120738,0
19 0032			225,0	112,00	16,00	14,9	20,50	4,50	0,281	1,125	128407,0	864	438	458	2,250	247489,0
19 0033			250,0	102,00	10,00	9,4	18,00	8,00	0,800	2,000	58157,0	1017	160	476	4,000	98485,0

\*\*)  $sc = h_0 = l_0 - t$  for disc springs without contact surfaces  
 $sc = h_0 = l_0 - t'$  for disc springs with contact surfaces

spring force F in N			stress $\sigma$ in N/mm <sup>2</sup>					$s_c^{**}$						Weight
$s = 0,5 h_0$			$s = 0,75 h_0$											1.000 pcs.
$\sigma_I$	$\sigma_{II}$	$\sigma_{III}$	s	F	$\sigma_I$	$\sigma_{II}$	$\sigma_{III}$	s	F	$\sigma_I$	$\sigma_{II}$	$\sigma_{III}$	in kg	
1423	474	790	3,375	41008,0	2016	830	1109	4,500	50260	2530	1264	1377	698,246	
1547	341	870	3,375	41008,0	2186	646	1218	4,900	50562	2908	1203	1599	651,696	
1658	836	902	2,625	138331,0	2403	1338	1299	4,100	204958	3533	2310	1889	1094,000	
1827	925	994	2,625	183518,0	2655	1474	1436	4,300	284160	4078	2686	2179	1187,000	
1537	115	877	4,650	26442,0	2128	350	1201	6,200	27966	2600	703	1450	708,337	
1597	30	916	4,650	26442,0	2208	233	1255	6,400	26839	2747	612	1540	678,822	
1331	368	742	3,825	37502,0	1875	672	1035	5,100	44930	2340	1057	1278	885,421	
1440	243	812	3,825	37502,0	2024	499	1132	5,500	44355	2654	974	1464	826,393	
1535	712	837	3,000	125417,0	2217	1153	1201	4,600	180562	3188	1979	1707	1387,000	
1653	922	892	2,625	237883,0	2412	1452	1294	4,400	381593	3811	2664	2021	1786,000	
1130	130	530	4,125	18400,0	1570	310	730	5,700	20100	1980	620	910	980,000	
1750	170	830	5,250	41200,0	2440	450	1140	7,200	44200	3050	900	1400	1190,000	
1847	431	857	4,650	78034,0	2611	806	1198	6,700	95329	3458	1466	1558	1539,000	
1810	540	830	4,500	89300,0	2580	960	1170	6,400	112100	3400	1620	1520	1660,000	
1862	691	846	4,125	129445,0	2665	1164	1198	6,100	173523	3669	1993	1622	1928,000	
1735	847	774	3,450	182737,0	2512	1361	1111	5,350	266449	3662	2345	1594	2308,000	
1360	780	600	2,625	174800,0	1990	1220	870	4,400	280300	3150	2240	1360	2480,000	
1873	665	943	4,200	137688,0	2677	1130	1336	6,200	183777	3673	1946	1806	1828,000	
1794	836	890	3,600	199269,0	2591	1354	1276	5,550	287825	3747	2335	1819	2187,000	
1706	931	837	3,075	267227,0	2485	1471	1211	5,050	418519	3846	2649	1850	2537,000	
1599	131	910	5,250	36111,0	2216	381	1247	7,000	38423	2709	752	1507	1004,000	
1655	54	946	5,250	36111,0	2289	274	1296	7,200	37138	2845	671	1590	967,970	
1601	409	892	4,200	76378,0	2268	747	1254	6,100	96202	3031	1347	1654	1368,000	
1790	440	1000	4,500	91800,0	2530	810	1400	6,500	114600	3370	1470	1840	1420,000	
1700	570	940	4,200	107100,0	2420	980	1330	6,000	138600	3220	1640	1750	1570,000	
1877	651	1036	4,200	145357,0	2682	1111	1468	6,200	194014	3676	1923	1987	1716,000	
1350	660	730	3,000	134500,0	1950	1050	1050	4,700	198700	2870	1840	1530	1880,000	
1532	766	831	3,150	183020,0	2221	1227	1196	4,950	272297	3282	2136	1747	2053,000	
1755	935	948	3,150	289181,0	2554	1481	1371	5,150	450249	3931	2667	2085	2381,000	
1430	200	880	4,500	39700,0	2000	450	1210	6,200	45100	2530	850	1520	980,000	
1564	772	923	3,150	195830,0	2266	1238	1330	4,950	291355	3345	2160	1944	1904,000	
1452	832	850	2,625	256758,0	2121	1306	1236	4,450	418407	3394	2414	1959	2209,000	
1290	810	750	2,250	269700,0	1900	1260	1100	4,000	465200	3200	2400	1840	2370,000	
1808	1032	1059	2,850	415725,0	2644	1616	1542	5,000	699348	4368	3106	2521	2505,000	
1482	136	825	5,325	44580,0	2063	364	1137	7,400	48614	2608	764	1418	1455,000	
1531	301	842	4,875	70749,0	2158	591	1176	7,000	85127	2836	1110	1524	1761,000	
1660	410	910	4,875	98800,0	2350	760	1270	7,050	123300	3130	1370	1670	1980,000	
1680	520	910	4,650	126700,0	2400	910	1290	6,800	164800	3240	1590	1720	2200,000	
1630	560	880	4,275	144400,0	2340	960	1250	6,500	197000	3290	1720	1740	2350,000	
1488	666	794	3,750	171016,0	2146	1084	1137	5,750	244783	3080	1872	1612	2641,000	
1680	923	886	3,375	359590,0	2449	1456	1283	5,600	569897	3829	2651	1983	3498,000	
1922	432	889	6,000	126387,0	2713	817	1241	8,600	152967	3574	1487	1605	3019,000	

Tab. III: Disc Springs according to DIN and Mubea standard

STANDARD DIMENSIONS ACCORDING TO DIN EN 16983 (FORMER DIN 2093) AND MUBEA STANDARDS

Part No.	DIN Series	not on Stock	Dimensions in mm							spring deflection s in mm					spring force F in N	
			D <sub>e</sub>	D <sub>i</sub>	t	t'	l <sub>0</sub>	h <sub>0</sub>	h <sub>0</sub> /t	s = 0,25 h <sub>0</sub>					s = 0,5 h <sub>0</sub>	
										s	F	σ <sub>I</sub>	σ <sub>II</sub>	σ <sub>III</sub>	s	F
19 0034			250,0	102,00	12,00	11,25	19,00	7,00	0,583	1,750	75052,0	971	276	445	3,500	134524,0
19 0035	C		250,0	127,00	7,00	6,7	14,80	7,80	1,114	1,950	26895,0	767	10	438	3,900	42527,0
19 0050		*	250,0	127,00	7,50	7	16,50	9,00	1,200	2,250	41900,0	1000	53	580	4,500	64400,0
19 0036			250,0	127,00	8,00	7,5	16,00	8,00	1,000	2,000	38439,0	877	30	500	4,000	61836,0
19 0051		*	250,0	127,00	9,00	8,45	16,60	7,60	0,844	1,900	45900,0	880	98	500	3,800	76800,0
19 0052		*	250,0	127,00	9,20	8,6	17,40	8,20	0,891	2,050	55200,0	990	80	560	4,100	91000,0
19 0037	B		250,0	127,00	10,00	9,4	17,00	7,00	0,700	1,750	51871,0	842	163	471	3,500	90206,0
19 0053		*	250,0	127,00	10,50	9,9	18,00	7,50	0,714	1,875	64800,0	950	180	530	3,750	112500,0
19 0054		*	250,0	127,00	11,00	10,4	18,80	7,80	0,709	1,950	77000,0	1030	200	580	3,900	133900,0
19 0038			250,0	127,00	12,00	11,25	19,30	7,30	0,608	1,825	87633,0	1011	251	563	3,650	156021,0
19 0055		*	250,0	127,00	13,00	12,2	19,60	6,60	0,508	1,650	93900,0	940	300	520	3,300	171800,0
19 0056		*	250,0	127,00	13,50	12,6	19,60	6,10	0,452	1,525	94200,0	880	310	480	3,050	174400,0
19 0039	A		250,0	127,00	14,00	13,1	19,60	5,60	0,400	1,400	93239,0	813	328	444	2,800	175145,0
19 0057		*	250,0	127,00	14,50	13,6	20,00	5,50	0,379	1,375	100400,0	820	350	440	2,750	189700,0
19 0058		*	250,0	127,00	15,00	14,1	21,00	6,00	0,400	1,500	122500,0	930	380	510	3,000	230500,0
19 0040			250,0	127,00	16,00	14,9	21,80	5,80	0,362	1,450	141529,0	949	406	517	2,900	267853,0
19 0059		*	250,0	127,00	16,80	15,65	22,00	5,20	0,310	1,300	142800,0	870	410	470	2,600	273500,0
19 0060		*	250,0	127,00	17,50	16,35	22,00	4,50	0,257	1,125	136000,0	750	400	400	2,250	263600,0
19 0061		*	250,0	127,00	18,50	17,3	23,00	4,50	0,243	1,125	159700,0	790	440	420	2,250	310400,0
19 0062		*	270,0	127,00	10,65	10	18,00	7,35	0,690	1,838	53800,0	800	160	420	3,675	93700,0
19 0063		*	270,0	142,00	22,00		26,90	4,90	0,223	1,225	248700,0	780	550	430	2,450	490700,0
19 0064		*	280,0	127,00	12,00	11,4	21,40	9,40	0,783	2,350	95400,0	1110	190	560	4,700	163100,0
19 0065		*	280,0	127,00	19,00	18	25,00	6,00	0,316	1,500	178200,0	880	450	430	3,000	342600,0
19 0066		*	280,0	142,00	12,00	11,3	21,00	9,00	0,750	2,250	95100,0	1060	180	590	4,500	163400,0
19 0067		*	280,0	142,00	15,00	14,1	21,40	6,40	0,427	1,600	105700,0	800	310	440	3,200	197600,0
19 0068		*	280,0	142,00	16,60	15,6	23,25	6,65	0,401	1,663	146600,0	910	370	490	3,325	275800,0
19 0069		*	280,0	142,00	17,45	16,4	23,90	6,45	0,370	1,613	162300,0	910	400	490	3,225	307600,0
19 0070		*	280,0	142,00	18,00	16,9	24,00	6,00	0,333	1,500	162600,0	860	400	460	3,000	310600,0
19 0071		*	280,0	142,00	18,90	17,8	24,60	5,70	0,302	1,425	175800,0	830	420	450	2,850	338300,0
19 0072		*	280,0	142,00	20,30	19,1	25,40	5,10	0,251	1,275	190600,0	780	430	420	2,550	370300,0
19 0073		*	280,0	142,00	22,00	20,65	26,35	4,35	0,198	1,088	202800,0	700	430	370	2,175	397600,0
19 0074		*	280,0	152,00	12,80	11,9	19,80	7,00	0,547	1,750	82100,0	820	220	480	3,500	148000,0
19 0075		*	280,0	152,00	15,00	14	21,40	6,40	0,427	1,600	111300,0	820	300	480	3,200	207500,0
19 0076		*	280,0	152,00	18,50	17,4	23,60	5,10	0,276	1,275	152700,0	730	380	420	2,550	295400,0
19 0077		*	300,0	127,00	12,00	11,3	21,00	9,00	0,750	2,250	76300,0	930	170	440	4,500	131000,0
19 0078		*	300,0	127,00	13,00	12,3	20,50	7,50	0,577	1,875	70900,0	770	230	360	3,750	127800,0
19 0079		*	300,0	127,00	14,00	13,3	21,00	7,00	0,500	1,750	78300,0	740	270	340	3,500	144200,0
19 0080		*	300,0	127,00	15,30		22,80	7,50	0,490	1,875	104600,0	800	370	370	3,750	197000,0
19 0081		*	300,0	127,00	16,00	15,2	24,30	8,30	0,519	2,075	140200,0	1010	350	470	4,150	257000,0
19 0082		*	300,0	127,00	17,00	16,1	23,80	6,80	0,400	1,700	128400,0	830	360	380	3,400	242200,0
19 0083		*	300,0	127,00	17,40	16,45	22,65	5,25	0,302	1,313	101100,0	620	320	280	2,625	194800,0
19 0084		*	300,0	152,00	8,50	8,25	16,80	8,30	0,976	2,075	31300,0	640	60	360	4,150	51500,0

\*\*\*)  $sc = h_0 = l_0 - t$  for disc springs without contact surfaces  
 $sc = h_0 = l_0 - t'$  for disc springs with contact surfaces

spring force F in N			stress $\sigma$ in N/mm <sup>2</sup>					$s_c^{**}$					Weight
$s = 0,5 h_0$			$s = 0,75 h_0$										1.000 pcs.
$\sigma_I$	$\sigma_{II}$	$\sigma_{III}$	s	F	$\sigma_I$	$\sigma_{II}$	$\sigma_{III}$	s	F	$\sigma_I$	$\sigma_{II}$	$\sigma_{III}$	in kg
1854	640	842	5,250	182962,0	2648	1093	1190	7,750	242024	3630	1894	1603	3613,000
1430	123	810	5,850	50466,0	1989	340	1116	8,100	54733	2506	718	1388	1915,000
1860	40	1060	6,750	73500,0	2580	270	1460	9,500	75100	3260	740	1820	2000,000
1641	173	928	6,000	74819,0	2292	429	1284	8,500	83455	2947	908	1628	2144,000
1650	300	930	5,700	97300,0	2330	600	1290	8,150	115600	3040	1150	1670	2420,000
1860	280	1050	6,150	113400,0	2620	600	1460	8,800	132000	3410	1200	1870	2460,000
1595	415	886	5,250	119053,0	2260	755	1244	7,600	149964	3014	1350	1638	2687,000
1800	460	1000	5,625	148100,0	2550	840	1400	8,100	185500	3380	1500	1840	2830,000
1950	520	1080	5,850	176900,0	2760	940	1520	8,400	222000	3660	1650	1990	2970,000
1926	599	1063	5,475	210806,0	2743	1045	1502	8,050	275879	3730	1839	2016	3216,000
1800	680	990	4,950	238300,0	2580	1150	1400	7,400	325800	3590	1980	1930	3490,000
1700	700	930	4,575	244700,0	2440	1150	1320	7,000	345300	3480	2010	1860	3600,000
1568	715	851	4,200	248828,0	2264	1160	1221	6,500	360229	3281	2018	1748	3745,000
1570	750	850	4,125	270800,0	2280	1210	1220	6,400	395600	3310	2090	1760	3890,000
1790	830	970	4,500	327900,0	2580	1350	1390	6,900	472100	3720	2310	1980	4030,000
1833	875	993	4,350	383017,0	2655	1408	1428	6,900	570770	3944	2500	2096	4260,000
1680	880	900	3,900	395400,0	2440	1390	1310	6,350	611600	3740	2510	1980	4470,000
1460	850	780	3,375	384900,0	2140	1330	1140	5,650	619500	3390	2410	1780	4670,000
1530	910	820	3,375	454300,0	2240	1420	1190	5,700	739800	3590	2600	1890	4950,000
1520	410	790	5,513	123900,0	2150	740	1110	8,000	156700	2880	1320	1460	3500,000
1530	1130	830	3,675	728300,0	2250	1750	1210	4,900	963500	2930	2400	1580	7150,000
2090	500	1060	7,050	211600,0	2950	940	1480	10,000	258300	3860	1650	1900	4380,000
1710	950	830	4,500	496800,0	2490	1510	1200	7,000	741600	3670	2550	1740	6910,000
2000	470	1110	6,750	212900,0	2820	880	1560	9,700	262900	3730	1590	2030	4060,000
1540	680	840	4,800	279500,0	2220	1120	1200	7,300	396800	3160	1910	1690	5060,000
1750	810	950	4,988	392300,0	2530	1310	1360	7,650	564800	3640	2260	1930	5600,000
1760	860	950	4,838	440400,0	2540	1380	1360	7,500	645100	3700	2380	1960	5890,000
1660	860	890	4,500	447900,0	2400	1370	1290	7,100	672000	3570	2370	1890	6070,000
1620	890	870	4,275	491000,0	2350	1410	1250	6,800	748700	3540	2450	1870	6390,000
1510	903	810	3,825	542100,0	2210	1410	1170	6,300	862700	3460	2510	1820	6860,000
1360	880	720	3,263	586300,0	2000	1360	1060	5,700	996900	3330	2550	1740	7410,000
1560	520	910	5,250	202500,0	2230	890	1290	7,900	273200	3110	1590	1780	4060,000
1580	670	910	4,800	292700,0	2270	1100	1300	7,400	418700	3260	1930	1850	4770,000
1420	800	810	3,825	430600,0	2060	1270	1170	6,200	671500	3170	2230	1780	5930,000
1750	440	830	6,750	170700,0	2480	810	1170	9,700	210800	3280	1440	1520	5150,000
1460	530	680	5,625	174900,0	2090	900	970	8,200	231100	2840	1520	1290	5600,000
1410	600	660	5,250	201400,0	2030	980	930	7,700	273700	2790	1630	1260	6060,000
1540	800	700	5,625	281200,0	2210	1290	1000	7,500	361400	2830	1840	1270	6970,000
1930	790	900	6,225	357400,0	2770	1310	1270	9,100	482200	3790	2170	1720	6920,000
1600	780	730	5,100	345500,0	2310	1260	1050	7,700	492600	3280	2100	1470	7330,000
1200	690	550	3,938	283000,0	1750	1080	790	6,200	428200	2620	1840	1160	7490,000
1200	200	670	6,225	64100,0	1680	420	930	8,550	73700	2130	760	1160	3400,000

Tab. III: Disc Springs according to DIN and Mubea standard

STANDARD DIMENSIONS ACCORDING TO DIN EN 16983 (FORMER DIN 2093) AND MUBEA STANDARDS

Part No.	DIN Series	not on Stock	Dimensions in mm							spring deflection s in mm					spring force F in N	
			D <sub>e</sub>	D <sub>i</sub>	t	t'	l <sub>0</sub>	h <sub>0</sub>	h <sub>0</sub> /t	s = 0,25 h <sub>0</sub>					s = 0,5 h <sub>0</sub>	
										s	F	σ <sub>I</sub>	σ <sub>II</sub>	σ <sub>III</sub>	s	F
19 0085		*	300,0	152,00	10,00	9,4	20,00	10,00	1,000	2,500	64900,0	950	40	540	5,000	104500,0
19 0086		*	300,0	152,00	12,00	11,3	21,00	9,00	0,750	2,250	82800,0	920	150	520	4,500	142200,0
19 0087		*	300,0	152,00	13,00	12,2	22,00	9,00	0,692	2,250	101200,0	970	190	540	4,500	176200,0
19 0088		*	300,0	152,00	14,00	13,2	22,00	8,00	0,571	2,000	102500,0	880	250	480	4,000	184700,0
19 0089		*	300,0	152,00	14,50	13,6	22,00	7,50	0,517	1,875	103400,0	830	260	460	3,750	188600,0
19 0090		*	300,0	152,00	15,00	14,1	23,00	8,00	0,533	2,000	123100,0	920	280	510	4,000	223900,0
19 0091		*	300,0	152,00	15,50	14,6	23,50	8,00	0,516	2,000	134100,0	940	300	520	4,000	245200,0
19 0092		*	300,0	152,00	16,10	15,1	23,70	7,60	0,472	1,900	139200,0	910	320	500	3,800	257000,0
19 0093		*	300,0	152,00	16,50		23,00	6,50	0,394	1,625	117500,0	700	370	380	3,250	225600,0
19 0094		*	300,0	152,00	17,00	16	24,40	7,40	0,435	1,850	155600,0	920	350	500	3,700	290300,0
19 0095		*	300,0	152,00	18,00	16,8	25,00	7,00	0,389	1,750	170900,0	910	370	490	3,500	321700,0
19 0096		*	300,0	152,00	18,50	17,4	25,00	6,50	0,351	1,625	167900,0	840	380	450	3,250	319600,0
19 0097		*	300,0	152,00	19,50	18,3	26,20	6,70	0,344	1,675	202200,0	910	420	490	3,350	385200,0
19 0098		*	300,0	152,00	20,00	18,8	25,50	5,50	0,275	1,375	173000,0	730	390	390	2,750	334500,0
19 0099		*	300,0	152,00	20,50	19,3	26,50	6,00	0,293	1,500	204700,0	820	420	440	3,000	394700,0
19 0100		*	300,0	182,00	12,00	11,1	18,00	6,00	0,500	1,500	54400,0	590	170	380	3,000	99100,0
19 0101		*	320,0	172,00	8,10	7,6	16,30	8,20	1,012	2,050	26200,0	560	10	340	4,100	42000,0
19 0102		*	320,0	172,00	9,00	8,5	19,00	10,00	1,111	2,500	47000,0	790	10	470	5,000	73900,0
19 0103		*	320,0	172,00	13,00	12,2	20,00	7,00	0,538	1,750	64400,0	620	180	360	3,500	117000,0
19 0104		*	320,0	172,00	15,00	14,1	21,00	6,00	0,400	1,500	77600,0	570	230	330	3,000	146100,0
19 0105		*	340,0	172,00	9,20	8,65	19,40	10,20	1,109	2,550	43700,0	720	10	410	5,100	68600,0
19 0106		*	340,0	172,00	9,50	8,9	20,80	11,30	1,189	2,825	57000,0	850	40	490	5,650	87900,0
19 0107		*	340,0	172,00	10,50	9,9	22,50	12,00	1,143	3,000	78300,0	980	20	560	6,000	122200,0
19 0108		*	340,0	172,00	11,00	10,4	22,40	11,40	1,036	2,850	78300,0	930	30	530	5,700	125400,0
19 0109		*	340,0	172,00	11,50	10,8	22,90	11,40	0,991	2,850	87000,0	970	40	550	5,700	140300,0
19 0110		*	340,0	172,00	12,50	11,8	23,00	10,50	0,840	2,625	90800,0	900	110	510	5,250	152500,0
19 0111		*	340,0	172,00	13,50	12,7	23,50	10,00	0,741	2,500	101300,0	890	150	500	5,000	174300,0
19 0112		*	340,0	172,00	13,70	12,9	24,30	10,60	0,774	2,650	115000,0	970	150	550	5,300	196200,0
19 0113		*	340,0	172,00	14,20	13,3	24,40	10,20	0,718	2,550	118800,0	950	170	530	5,100	205200,0
19 0114		*	340,0	172,00	14,60	13,7	25,10	10,50	0,719	2,625	132700,0	1010	180	560	5,250	229400,0
19 0115		*	340,0	172,00	15,30	14,4	24,70	9,40	0,614	2,350	126200,0	900	220	500	4,700	224700,0
19 0116		*	340,0	172,00	15,80	14,8	25,50	9,70	0,614	2,425	144000,0	960	230	530	4,850	255900,0
19 0117		*	340,0	172,00	16,20	15,2	25,60	9,40	0,580	2,350	146700,0	940	250	520	4,700	263200,0
19 0118		*	340,0	172,00	17,00	16	25,30	8,30	0,488	2,075	140300,0	820	280	450	4,150	258300,0
19 0119		*	340,0	172,00	17,30	16,3	26,10	8,80	0,509	2,200	158700,0	900	290	490	4,400	290800,0
19 0120		*	340,0	172,00	18,00	16,9	26,00	8,00	0,444	2,000	156400,0	820	310	450	4,000	291000,0
19 0121		*	340,0	172,00	20,00	18,7	28,00	8,00	0,400	2,000	209500,0	900	360	490	4,000	393500,0
19 0122		*	340,0	172,00	22,00	20,6	28,00	6,00	0,273	1,500	195500,0	690	360	370	3,000	377900,0
19 0123		*	360,0	182,00	15,50	14,6	23,50	8,00	0,516	2,000	93000,0	650	210	360	4,000	170000,0
19 0124		*	360,0	182,00	20,00	18,8	28,30	8,30	0,415	2,075	194800,0	830	330	450	4,150	365200,0
19 0125		*	360,0	182,00	21,00	19,7	28,00	7,00	0,333	1,750	182000,0	700	330	380	3,500	347500,0
19 0126		*	360,0	182,00	21,50	20,2	29,50	8,00	0,372	2,000	227700,0	840	370	460	4,000	431200,0

\*\*\*)  $sc = h_0 = l_0 - t$  for disc springs without contact surfaces  
 $sc = h_0 = l_0 - t'$  for disc springs with contact surfaces

spring force F in N			stress $\sigma$ in N/mm <sup>2</sup>					$s_c^{**}$					Weight
$s = 0,5 h_0$			$s = 0,75 h_0$										1.000 pcs.
$\sigma_I$	$\sigma_{II}$	$\sigma_{III}$	s	F	$\sigma_I$	$\sigma_{II}$	$\sigma_{III}$	s	F	$\sigma_I$	$\sigma_{II}$	$\sigma_{III}$	in kg
1780	190	1000	7,500	126600,0	2480	470	1390	10,600	141500	3180	990	1750	3880,000
1740	410	970	6,750	185300,0	2460	760	1350	9,700	228900	3250	1380	1770	4660,000
1850	480	1020	6,750	232800,0	2620	880	1440	9,800	294200	3500	1580	1900	5030,000
1670	580	920	6,000	252700,0	2380	980	1300	8,800	335200	3250	1690	1750	5440,000
1590	590	870	5,625	260900,0	2280	1000	1240	8,400	355300	3170	1730	1700	5610,000
1770	650	970	6,000	308900,0	2530	1090	1370	8,900	417100	3490	1880	1870	5820,000
1800	690	990	6,000	339900,0	2590	1150	1400	8,900	461800	3570	1970	1910	6020,000
1750	710	960	5,700	359500,0	2520	1180	1360	8,600	500100	3550	2030	1890	6230,000
1350	790	720	4,875	327600,0	1960	1260	1040	6,500	426400	2520	1770	1320	6810,000
1760	770	960	5,550	410000,0	2540	1270	1370	8,400	578800	3600	2160	1920	6600,000
1750	800	950	5,250	457700,0	2520	1300	1360	8,200	669000	3690	2280	1960	6930,000
1620	820	870	4,875	459500,0	2350	1300	1250	7,600	679600	3440	2250	1820	7180,000
1760	890	950	5,025	554200,0	2550	1420	1360	7,900	826600	3770	2480	1990	7550,000
1420	810	760	4,125	487600,0	2070	1280	1100	6,700	761900	3190	2260	1680	7750,000
1600	900	860	4,500	573800,0	2330	1410	1240	7,200	881200	3530	2460	1860	7960,000
1130	390	730	4,500	136900,0	1620	660	1030	6,900	189600	2290	1210	1450	3890,000
1050	100	630	6,150	50600,0	1470	260	870	8,700	56200	1890	570	1100	3410,000
1470	90	880	7,500	87100,0	2050	302	1210	10,500	93500	2590	690	1510	3820,000
1190	420	690	5,250	161000,0	1710	720	980	7,800	217100	2360	1250	1330	5480,000
1100	510	630	4,500	207900,0	1590	820	900	6,900	299300	2290	1410	1280	6330,000
1350	90	760	7,650	80700,0	1870	280	1050	10,750	86300	2380	640	1320	4590,000
1590	50	900	8,475	100800,0	2200	250	1240	11,900	104000	2790	650	1550	4720,000
1830	100	1030	9,000	142500,0	2540	350	1420	12,600	150800	3210	830	1780	5250,000
1750	180	980	8,550	151000,0	2440	450	1360	12,000	167000	3110	940	1710	5520,000
1810	200	1020	8,550	170400,0	2530	490	1410	12,100	191000	3250	1020	1790	5730,000
1700	330	950	7,875	194000,0	2390	650	1320	11,200	231400	3120	1200	1700	6260,000
1690	400	940	7,500	227600,0	2390	750	1310	10,800	282100	3160	1360	1720	6740,000
1840	410	1020	7,950	253900,0	2600	780	1430	11,400	310700	3420	1420	1860	6840,000
1800	440	1000	7,650	268900,0	2550	810	1400	11,100	336100	3410	1480	1850	7050,000
1910	470	1060	7,875	300900,0	2700	870	1480	11,400	376100	3590	1570	1950	7270,000
1700	540	940	7,050	303700,0	2430	930	1320	10,300	396100	3290	1630	1770	7640,000
1830	560	1010	7,275	345200,0	2600	980	1420	10,700	450700	3540	1730	1910	7850,000
1790	590	980	7,050	358400,0	2550	1020	1390	10,400	474600	3480	1780	1870	8060,000
1580	630	860	6,225	360400,0	2270	1050	1230	9,300	496100	3160	1790	1690	8490,000
1720	660	940	6,600	403900,0	2460	1110	1330	9,800	550500	3410	1900	1820	8640,000
1580	680	860	6,000	409800,0	2280	1110	1230	9,100	577300	3230	1910	1720	8960,000
1730	790	940	6,000	558900,0	2500	1280	1340	9,300	809800	3630	2230	1920	9920,000
1330	760	710	4,500	550600,0	1950	1190	1030	7,400	869300	3020	2130	1590	10900,000
1250	480	680	6,000	235700,0	1800	800	970	8,900	320300	2480	1370	1330	8680,000
1600	730	870	6,225	518000,0	2310	1180	1240	9,400	739800	3310	2020	1750	11200,000
1370	700	730	5,250	501000,0	1980	1120	1060	8,300	752700	2950	1960	1560	11700,000
1630	790	880	6,000	617000,0	2350	1270	1260	9,300	902900	3430	2190	1810	12000,000

Tab. III: Disc Springs according to DIN and Mubea standard

STANDARD DIMENSIONS ACCORDING TO DIN EN 16983 (FORMER DIN 2093) AND MUBEA STANDARDS

Part No.	DIN Series	not on Stock	Dimensions in mm							spring deflection s in mm					spring force F in N	
										s = 0,25 h <sub>0</sub>					s = 0,5 h <sub>0</sub>	
			D <sub>e</sub>	D <sub>i</sub>	t	t'	l <sub>0</sub>	h <sub>0</sub>	h <sub>0</sub> /t	s	F	σ <sub>I</sub>	σ <sub>II</sub>	σ <sub>III</sub>	s	F
19 0127		*	360,0	182,00	23,00	21,6	30,20	7,20	0,313	1,800	243300,0	780	380	420	3,600	466700,0
19 0128		*	370,0	202,00	25,00	23,2	31,40	6,40	0,256	1,600	271200,0	710	370	410	3,200	525000,0
19 0129		*	370,0	202,00	26,00	24,2	32,80	6,80	0,262	1,700	324500,0	790	410	450	3,400	628000,0
19 0130		*	380,0	152,00	19,00	18	29,00	10,00	0,526	2,500	174600,0	920	310	410	5,000	319100,0
19 0131		*	380,0	192,00	13,50	12,7	26,20	12,70	0,941	3,175	120300,0	990	70	560	6,350	196600,0
19 0132		*	380,0	192,00	25,00	23,4	33,00	8,00	0,320	2,000	313100,0	860	410	460	4,000	599300,0
19 0133		*	380,0	202,00	12,00	11,5	25,00	13,00	1,083	3,250	98100,0	940	20	560	6,500	156300,0
19 0134		*	380,0	202,00	15,00	14,1	27,00	12,00	0,800	3,000	144400,0	990	130	580	6,000	244600,0
19 0135		*	380,0	212,00	18,00	16,7	27,00	9,00	0,500	2,250	158000,0	790	240	480	4,500	288300,0
19 0136		*	400,0	202,00	10,00	9,6	22,00	12,00	1,200	3,000	50100,0	680	10	390	6,000	77900,0
19 0137		*	400,0	202,00	12,00	11,3	26,50	14,50	1,208	3,625	107500,0	1000	40	570	7,250	165400,0
19 0138		*	400,0	202,00	14,00	13,2	27,00	13,00	0,929	3,250	122400,0	940	70	530	6,500	200800,0
19 0139		*	400,0	202,00	16,00	15,1	28,00	12,00	0,750	3,000	146600,0	920	160	510	6,000	252100,0
19 0140		*	400,0	202,00	19,00	17,9	30,00	11,00	0,579	2,750	198900,0	920	260	510	5,500	357700,0
19 0141		*	400,0	202,00	20,30	19,1	31,10	10,80	0,532	2,700	230900,0	950	290	520	5,400	420300,0
19 0142		*	400,0	202,00	21,20	19,9	31,40	10,20	0,481	2,550	240700,0	910	310	500	5,100	443500,0
19 0143		*	400,0	202,00	22,50	21,2	32,50	10,00	0,444	2,500	274900,0	930	350	500	5,000	512000,0
19 0144		*	400,0	202,00	30,00	28,2	37,20	7,20	0,240	1,800	422500,0	790	450	420	3,600	822700,0
19 0145		*	440,0	212,00	18,50		32,00	13,50	0,730	3,375	190400,0	910	250	480	6,750	338500,0
19 0146		*	440,0	252,00	25,00	23,2	33,00	8,00	0,320	2,000	257500,0	670	300	400	4,000	491700,0
19 0147		*	450,0	202,00	25,50	24	34,10	8,60	0,337	2,150	241500,0	670	320	330	4,300	461200,0
19 0148		*	450,0	252,00	21,00	19,5	33,00	12,00	0,571	3,000	251200,0	910	230	550	6,000	449800,0
19 0149		*	450,0	252,00	25,00	23,3	33,80	8,80	0,352	2,200	269500,0	700	300	420	4,400	511400,0
19 0150		*	470,0	237,00	33,00	31	42,00	9,00	0,273	2,250	516100,0	800	430	430	4,500	999000,0
19 0151		*	480,0	252,00	20,30	19	33,00	12,70	0,626	3,175	207400,0	820	190	470	6,350	367200,0
19 0152		*	480,0	252,00	20,70		36,60	15,90	0,768	3,975	285500,0	1030	260	590	7,950	502600,0
19 0153		*	500,0	202,00	37,00	35	44,40	7,40	0,200	1,850	466200,0	630	400	270	3,700	914900,0
19 0154		*	500,0	242,00	32,00	30	41,00	9,00	0,281	2,250	408400,0	690	360	360	4,500	788400,0
19 0155		*	500,0	252,00	19,00		34,50	15,50	0,816	3,875	200100,0	860	190	480	7,750	348100,0
19 0156		*	600,0	282,00	22,00		44,00	22,00	1,000	5,500	340100,0	1070	140	560	11,000	564800,0
19 0157		*	600,0	282,00	24,00		46,00	22,00	0,917	5,500	413600,0	1120	200	590	11,000	701300,0

Furthermore we also offer other, customized dimensions on request.

\*\*)  $sc = h_0 = l_0 - t$  for disc springs without contact surfaces  
 $sc = h_0 = l_0 - t'$  for disc springs with contact surfaces



spring force F in N			stress $\sigma$ in N/mm <sup>2</sup>					$s_c^{**}$					Weight
$s = 0,5 h_0$			$s = 0,75 h_0$										1.000 pcs.
$\sigma_I$	$\sigma_{II}$	$\sigma_{III}$	s	F	$\sigma_I$	$\sigma_{II}$	$\sigma_{III}$	s	F	$\sigma_I$	$\sigma_{II}$	$\sigma_{III}$	in kg
1520	810	810	5,400	675700,0	2210	1290	1180	8,600	1027000	3320	2250	1750	12800,000
1390	780	790	4,800	765700,0	2030	1220	1160	8,200	1252000	3260	2290	1840	13700,000
1530	860	880	5,100	915500,0	2240	1350	1270	8,600	1480000	3550	2490	2010	14300,000
1760	710	780	7,500	442400,0	2520	1180	1100	11,000	596100	3460	1960	1490	13500,000
1850	260	1040	9,525	242400,0	2600	570	1440	13,500	277600	3350	1130	1840	8420,000
1660	870	890	6,000	865600,0	2410	1380	1290	9,600	1318000	3640	2440	1910	15500,000
1760	170	1040	9,750	187300,0	2450	440	1430	13,500	205700	3100	920	1780	7350,000
1860	380	1080	9,000	313900,0	2630	730	1510	12,900	379900	3450	1360	1960	9000,000
1520	540	910	6,750	398700,0	2180	920	1290	10,300	551200	3070	1650	1800	10200,000
1260	70	710	9,000	90400,0	1750	250	980	12,400	95200	2190	560	1210	7050,000
1860	50	1060	10,875	189200,0	2580	290	1450	15,200	194700	3250	760	1800	8300,000
1760	260	990	9,750	248900,0	2470	560	1370	13,800	286700	3190	1100	1750	9700,000
1735	410	960	9,000	328800,0	2450	770	1350	12,900	406200	3240	1390	1750	11100,000
1760	600	960	8,250	488200,0	2510	1020	1360	12,100	645800	3420	1760	1830	13200,000
1810	670	990	8,100	580100,0	2590	1120	1400	12,000	783300	3570	1930	1910	14000,000
1750	700	950	7,650	619200,0	2510	1160	1360	11,500	857100	3520	2000	1880	14600,000
1780	770	960	7,500	722000,0	2560	1270	1380	11,300	1014000	3610	2150	1920	15600,000
1540	930	820	5,400	1206000,0	2250	1460	1190	9,000	1945000	3570	2620	1860	20700,000
1720	600	900	10,125	458400,0	2440	1040	1270	13,500	564300	3060	1570	1570	17000,000
1290	640	780	6,000	708500,0	1870	1030	1120	9,800	1094000	2870	1870	1700	18600,000
1300	690	630	6,450	665000,0	1890	1090	900	10,100	991000	2800	1880	1320	23900,000
1740	540	1050	9,000	610900,0	2480	940	1480	13,500	814900	3430	1700	2030	16700,000
1360	650	800	6,600	733000,0	1970	1050	1160	10,500	1099000	2940	1870	1710	20000,000
1560	900	830	6,750	1456000,0	2280	1410	1210	11,000	2282000	3520	2490	1840	31500,000
1560	460	890	9,525	493500,0	2220	810	1250	14,000	641300	3010	1440	1680	19600,000
1950	630	1110	11,925	674300,0	2760	1100	1550	15,900	823100	3460	1690	1930	21300,000
1240	830	530	5,550	1350000,0	1820	1280	770	9,400	2233000	2950	2310	1240	45100,000
1350	760	690	6,750	1147000,0	1960	1200	1000	11,000	1794000	3030	2120	1520	35400,000
1630	480	900	11,625	461300,0	2310	870	1250	15,500	557200	2880	1350	1550	21900,000
2000	420	1050	16,500	712400,0	2810	8201	1450	22,000	821500	3480	1360	1780	38000,000
2110	530	1100	16,500	905000,0	2970	990	1530	22,000	1066000	3700	1580	1880	41500,000

Tab. III: Disc Springs according to DIN and Mubea standard

### III.I MUBEA DISC SPRINGS MADE FROM CORROSION RESISTANT MATERIALS

material X 12 CrNi 17 7, material no. 1.4310, modulus of elasticity=190.000 N/mm<sup>2</sup> at +20 °C

Part No.	Dimensions in mm							spring deflection s in mm					spring force F in N				
								s = 0,25 h <sub>0</sub>					s = 0,5 h <sub>0</sub>				
	D <sub>e</sub>	D <sub>i</sub>	t	t'	l <sub>0</sub>	h <sub>0</sub>	h <sub>0</sub> /t	s	F	σ <sub>I</sub>	σ <sub>II</sub>	σ <sub>III</sub>	s	F	σ <sub>I</sub>	σ <sub>II</sub>	σ <sub>III</sub>
17 1005	8,0	4,20	0,30		0,50	0,20	0,666	0,050	33,8	593	187	337	0,100	61,0	1128	431	636
17 1006	8,0	4,20	0,40		0,60	0,20	0,500	0,050	72,2	723	317	405	0,100	136,0	1388	691	722
17 1014	10,0	5,20	0,40		0,65	0,25	0,625	0,063	61,9	618	213	347	0,125	113,0	1178	483	656
17 1015	10,0	5,20	0,50		0,70	0,20	0,400	0,050	85,1	545	286	300	0,100	163,3	1053	608	576
17 1016	12,0	4,20	0,40		0,80	0,40	1,000	0,100	78,6	864	138	355	0,200	130,4	1624	379	659
17 1017	12,0	4,20	0,50		0,80	0,30	0,600	0,075	85,9	674	265	265	0,150	157,7	1289	589	502
17 1024	12,5	6,20	0,50		0,85	0,35	0,700	0,088	110,8	715	213	387	0,175	198,4	1359	497	730
17 1025	12,5	6,20	0,70		0,95	0,25	0,357	0,063	178,0	592	336	310	0,125	344,3	1148	708	598
17 1027	14,0	7,20	0,50		0,90	0,40	0,800	0,100	110,8	687	160	387	0,200	193,5	1299	395	725
17 1028	14,0	7,20	0,80		1,10	0,30	0,375	0,075	261,8	656	360	356	0,150	504,7	1270	762	686
17 1037	15,0	8,20	0,80		1,20	0,40	0,500	0,100	338,3	830	361	482	0,200	635,8	1593	789	920
17 1039	16,0	8,20	0,60		1,05	0,45	0,750	0,113	158,7	693	182	388	0,225	280,7	1313	437	729
17 1220	16,0	8,20	0,80		1,20	0,40	0,500	0,100	284,2	720	317	395	0,200	534,1	1383	691	753
17 1040	16,0	8,20	0,90		1,25	0,35	0,388	0,088	334,4	665	356	360	0,175	642,9	1286	756	693
17 1050	18,0	9,20	0,70		1,20	0,50	0,714	0,125	215,3	697	199	388	0,250	384,3	1323	469	731
17 1051	18,0	9,20	1,00		1,40	0,40	0,400	0,100	415,7	671	353	363	0,200	797,5	1297	751	698
17 1052	20,0	8,20	0,50		1,15	0,65	1,300	0,163	118,4	682	10,2	327	0,325	183,4	1268	116	601
17 1056	20,0	8,20	0,90		1,50	0,60	0,667	0,150	390,4	861	289	394	0,300	705,2	1641	659	742
17 0159	20,0	10,20	0,60		1,20	0,60	1,000	0,150	163,3	663	83	375	0,300	271,1	1244	249	698
17 1060	20,0	10,20	0,80		1,35	0,55	0,687	0,138	280,7	700	212	388	0,275	504,4	1330	494	732
17 0158	20,0	10,20	0,90		1,40	0,50	0,555	0,125	333,5	668	265	366	0,250	618,8	1278	588	696
17 1062	20,0	10,20	1,00		1,55	0,55	0,550	0,138	501,5	814	326	446	0,275	931,7	1558	722	848
17 1063	20,0	10,20	1,10		1,55	0,45	0,409	0,113	506,0	676	350	366	0,225	969,0	1306	746	702
17 1065	22,5	11,20	0,80		1,45	0,65	0,812	0,163	282,6	693	158	380	0,325	492,0	1310	392	712
18 1001	22,5	11,20	1,25		1,75	0,50	0,400	0,125	639,3	670	353	354	0,250	1227,0	1294	751	680
17 1072	25,0	12,20	0,70		1,60	0,90	1,285	0,225	305,5	832	3,5	460	0,450	474,7	1545	125	847
17 1073	25,0	12,20	0,90		1,60	0,70	0,777	0,175	338,4	668	167	359	0,350	594,3	1265	406	674
18 1004	25,0	12,20	1,50		2,00	0,50	0,333	0,125	859,4	625	369	322	0,250	1669,0	1213	775	621
17 1074	28,0	10,20	0,80		1,75	0,95	1,187	0,238	320,9	802	57	346	0,475	509,6	1498	221	638
18 1005	28,0	10,20	1,25		2,05	0,80	0,640	0,200	679,3	830	301	340	0,400	1235,0	1584	678	642
17 1078	28,0	14,20	1,00		1,80	0,80	0,800	0,200	439,4	685	160	382	0,400	767,4	1296	395	715
18 1010	28,0	14,20	1,50		2,15	0,65	0,433	0,163	953,1	689	342	372	0,325	1817,0	1328	734	712
18 1011	31,5	16,30	1,25		2,15	0,90	0,720	0,225	729,1	735	207	414	0,450	1300,0	1394	488	779
18 1013	31,5	16,30	1,75		2,45	0,70	0,400	0,175	1283,0	672	353	368	0,350	2462,0	1299	751	707
18 1021	35,5	18,30	1,25		2,25	1,00	0,800	0,250	674,2	668	155	377	0,500	1178,0	1263	383	707
18 1031	40,0	20,40	1,50		2,65	1,15	0,768	0,288	1023,0	714	181	398	0,575	1802,0	1351	437	747
18 1036	45,0	22,40	1,75		3,05	1,30	0,742	0,325	1406,0	733	198	400	0,650	2491,0	1390	472	751

\*)  $sc = h_0 = l_0 - t$  for disc springs without contact surfaces  
 $sc = h_0 = l_0 - t'$  for disc springs with contact surfaces

Furthermore we also offer other, customized dimensions on request.

Stress $\sigma$ in N/mm <sup>2</sup>					$s_c^*$					Weight
$s = 0,75 h_0$										1.000 pcs.
s	F	$\sigma_I$	$\sigma_{II}$	$\sigma_{III}$	s	F	$\sigma_I$	$\sigma_{II}$	$\sigma_{III}$	in kg
0,150	83,9	1605	734	897	0,200	105,0	2023	1095	1121	0,087
0,150	193,0	1994	1124	1102	0,200	248,0	2543	1615	1393	0,115
0,188	156,9	1680	812	928	0,250	197,2	2124	1198	1163	0,181
0,150	237,0	1524	968	827	0,200	308,1	1957	1365	1055	0,226
0,300	164,5	2280	725	911	0,400	189,7	2832	1174	1112	0,313
0,225	220,1	1846	971	710	0,300	277,9	2344	1411	888	0,390
0,263	270,7	1930	854	1027	0,350	335,2	2430	1282	1280	0,365
0,188	502,6	1667	1117	862	0,250	657,1	2149	1563	1104	0,511
0,300	257,5	1835	705	1016	0,400	312,1	2296	1091	1258	0,445
0,225	735,0	1842	1206	988	0,300	958,9	2371	1693	1263	0,715
0,300	906,0	2289	1284	1312	0,400	1162,6	2918	1846	1660	0,783
0,338	378,2	1859	765	1023	0,450	463,6	2333	1166	1270	0,702
0,300	761,2	1988	1123	1074	0,400	976,7	2535	1613	1358	0,940
0,263	934,2	1862	1200	997	0,350	1217,0	2395	1688	1272	1,060
0,375	522,4	1877	811	1028	0,500	645,2	2361	1223	1279	1,040
0,300	1157,0	1877	1195	1003	0,400	1505,0	2412	1684	1279	1,485
0,488	212,9	1758	318	822	0,650	224,6	2152	617	991	1,030
0,450	969,6	2339	1112	1045	0,600	1209,0	2954	1646	1304	1,858
0,450	342,0	1741	498	968	0,600	394,4	2156	830	1184	1,101
0,413	690,1	1891	846	1031	0,550	856,9	2382	1267	1286	1,470
0,375	872,0	1831	968	989	0,500	1109,0	2326	1405	1245	1,650
0,413	1315,0	2233	1188	1206	0,550	1674,0	2838	1723	1519	1,840
0,338	1403,0	1889	1190	1008	0,450	1823,0	2426	1679	1285	2,020
0,488	653,0	1850	703	995	0,650	789,0	2314	1090	1231	1,890
0,375	1779,0	1874	1195	977	0,500	2314,0	2408	1684	1245	2,950
0,675	553,1	2140	365	1161	0,900	586,1	2617	724	1401	2,070
0,525	795,3	1790	716	944	0,700	968,9	2243	1098	1170	2,660
0,375	2445,0	1765	1218	897	0,500	3204,0	2281	1696	1151	4,430
0,713	610,2	2088	491	876	0,950	666,7	2571	867	1060	3,480
0,600	1709,0	2263	1130	906	0,800	2142,0	2866	1658	1131	5,270
0,600	1021,0	1832	706	1001	0,800	1238,0	2293	1091	1240	3,610
0,488	2620,0	1918	1175	1021	0,650	3394,0	2459	1665	1298	5,420
0,675	1764,0	1978	846	1095	0,900	2176,0	2486	1279	1363	5,630
0,525	3571,0	1880	1195	1016	0,700	4645,0	2415	1685	1296	7,890
0,750	1567,0	1784	685	990	1,000	1899,0	2233	1060	1225	7,180
0,863	2418,0	1912	770	1048	1,150	2953,0	2397	1179	1300	11,020
0,975	3363,0	1970	823	1055	1,300	4128,0	2473	1250	1311	16,540

Tab. III.I: Mubea disc springs made from corrosion resistant materials

### III.I MUBEA DISC SPRINGS MADE FROM CORROSION RESISTANT MATERIALS

material no. X 7 CrNiAl 17 7, material no. 1.4568 / PH 17-7, modulus of elasticity=200.000 N/mm<sup>2</sup> at +20 °C

Part No.	Dimensions in mm							spring deflection s in mm					spring force F in N				
								s = 0,25 h <sub>0</sub>					s = 0,5 h <sub>0</sub>				
	D <sub>e</sub>	D <sub>i</sub>	t	t'	l <sub>0</sub>	h <sub>0</sub>	h <sub>0</sub> /t	s	F	σ <sub>I</sub>	σ <sub>II</sub>	σ <sub>III</sub>	s	F	σ <sub>I</sub>	σ <sub>II</sub>	σ <sub>III</sub>
18 4626	31,5	16,30	1,25		2,00	0,75	0,600	0,188	590,0	606	220	338	0,375	1083,0	1157	495	641
18 4627	31,5	16,30	1,75		2,30	0,55	0,314	0,138	1023,0	528	320	286	0,275	1992,0	1026	670	553
18 4628	35,5	18,30	2,00		2,65	0,65	0,325	0,163	1423,0	565	337	306	0,325	2767,0	1097	706	590
18 4629	40,0	20,40	1,50		2,45	0,95	0,633	0,238	810,8	580	197	320	0,475	1477,0	1106	449	606
18 4630	40,0	20,40	2,00		2,80	0,80	0,400	0,200	1416,0	572	301	309	0,400	2716,0	1106	640	594
18 4631	40,0	20,40	2,25		2,95	0,70	0,311	0,175	1698,0	534	326	285	0,350	3308,0	1037	681	552
18 4632	45,0	22,40	1,75		2,80	1,05	0,600	0,263	1085,0	579	212	312	0,525	1992,0	1106	476	592
18 4633	45,0	22,40	2,50		3,30	0,80	0,320	0,200	2080,0	537	324	281	0,400	4048,0	1044	678	544
18 4634	50,0	25,40	1,50		3,10	1,60	1,066	0,400	1206,0	766	72	434	0,800	1969,0	1433	243	804
18 4635	50,0	25,40	2,00		3,15	1,15	0,575	0,288	1431,0	581	222	318	0,575	2643,0	1110	495	604
18 4636	50,0	25,40	2,50		3,50	1,00	0,400	0,250	2207,0	572	301	308	0,500	4234,0	1105	640	591
18 4637	50,0	25,40	3,00		3,85	0,85	0,283	0,213	3088,0	543	347	288	0,425	6043,0	1058	722	559
18 4638	56,0	28,50	2,00		3,40	1,40	0,700	0,350	1510,0	602	178	333	0,700	2705,0	1143	416	628
18 4639	56,0	28,50	3,00		4,05	1,05	0,350	0,263	3124,0	558	319	299	0,525	6050,0	1081	672	576
18 4640	63,0	31,00	2,50		3,95	1,45	0,580	0,363	2186,0	577	220	307	0,725	4033,0	1102	491	582
18 4641	71,0	36,00	2,50		4,25	1,75	0,700	0,438	2288,0	585	173	323	0,875	4099,0	1110	404	608
18 4642	80,0	41,00	3,00		4,90	1,90	0,633	0,475	3253,0	581	197	322	0,950	5925,0	1106	449	609

\*)  $sc = h_0 = l_0 - t$  for disc springs without contact surfaces  
 $sc = h_0 = l_0 - t'$  for disc springs with contact surfaces

Furthermore we also offer other, customized dimensions on request.

Stress $\sigma$ in N/mm <sup>2</sup>					$s_c^*$					Weight
$s = 0,75 h_0$										1.000 pcs.
s	F	$\sigma_I$	$\sigma_{II}$	$\sigma_{III}$	s	F	$\sigma_I$	$\sigma_{II}$	$\sigma_{III}$	in kg
0,563	1512,0	1652	825	907	0,75	1909,0	2093	1210	1139	5,630
0,413	2926,0	1494	1049	801	0,55	3841,0	1933	1458	1030	7,890
0,488	4058,0	1596	1107	854	0,65	5322,0	2063	1542	1097	11,480
0,713	2046,0	1576	756	856	0,95	2568,0	1992	1117	1072	11,020
0,600	3940,0	1600	1019	853	0,80	5125,0	2056	1436	1088	14,680
0,525	4861,0	1512	1066	799	0,70	6385,0	1956	1481	1028	16,530
0,788	2780,0	1581	793	838	1,05	3510,0	2003	1163	1051	16,540
0,600	5940,0	1521	1063	787	0,80	7796,0	1967	1479	1011	23,630
1,200	2439,0	2001	513	1112	1,60	2761,0	2469	882	1356	17,260
0,863	3710,0	1589	820	856	1,15	4704,0	2016	1196	1077	23,020
0,750	6141,0	1600	1018	850	1,00	7989,0	2055	1435	1084	28,770
0,638	8910,0	1545	1125	812	0,85	11734,0	2004	1556	1047	34,520
1,050	3690,0	1623	715	884	1,40	4570,0	2043	1074	1102	28,840
0,788	8842,0	1571	1060	832	1,05	11568,0	2026	1481	1066	43,250
1,088	5654,0	1577	812	826	1,45	7162,0	2001	1185	1038	46,660
1,313	5592,0	1577	695	856	1,75	6925,0	1985	1044	1067	58,090
1,425	8210,0	1577	756	861	1,90	10301,0	1993	1117	1078	87,840

Tab. III.I: Mubea disc springs made from corrosion resistant materials

# IV DOWNLOADS

---

Downloads available under [www.mubea.com](http://www.mubea.com) in the disc spring section

- Calculation programm
- Force-displacement diagrams for standard parts
- General infomaterial



